



Sky Air Advance-series
Air Conditioning
Technical Data
RZASG-MV1



TABLE OF CONTENTS

RZASG-MV1

1	Features	4
	RZASG-MV1	4
2	Specifications	5
3	Electrical data	15
4	Options	16
5	Combination table	17
6	Capacity tables	18
	Cooling/Heating Capacity Tables	18
	Capacity Correction Factor	20
7	Dimensional drawings	21
8	Centre of gravity	22
9	Piping diagrams	24
	Piping Diagram Twin Application Piping	25
	Diagram Triple Application Piping	26
	Diagram Double Twin Application	27
10	Wiring diagrams	28
	Wiring Diagrams - Single Phase	28
11	Sound data	31
	Sound Power Spectrum	31
	Sound Pressure Spectrum - Cooling	33
	Sound Pressure Spectrum - Heating	35
	Sound Pressure Spectrum Quiet Mode	37
12	Installation	39
	Installation Method	39
13	Operation range	41
14	Appropriate Indoors	42

1 Features

1 - 1 RZASG-MV1

Technology and comfort combined for commercial applications

1

- > High efficiency: - Energy labels up to A++ (cooling) / A+ (heating) - compressor offers substantial efficiency improvements
- > Choosing for an R-32 product, reduces the environmental impact with 68% compared to R-410A, leads directly to lower energy consumption thanks to its high energy efficiency and has a lower refrigerant charge
- > Very compact and easy to install
- > Replace existing systems with R-32 technology without needing to replace the piping
- > Guarantees operation in both heating and cooling mode down to -15°C
- > Refrigerant cooled PCB guarantees reliable cooling, as it is not influenced by ambient temperature.
- > Maximum piping length up to 50m, minimum piping length has no limitation
- > Outdoor units for pair, twin, triple, double twin application



Vertical auto swing



Auto cooling-heating changeover

2 Specifications

1 - 1 RZASG-MV1

Technical Specifications					RZASG71MV1	RZASG100MV1	RZASG125MV1	RZASG140MV1	
Casing	Colour				Ivory white				
	Material				Painted galvanized steel plate				
Dimensions	Unit	Height	mm	770	990				
		Width	mm	900	940				
		Depth	mm	320					
	Packed unit	Height	mm	900	1,170				
		Width	mm	980	1,015				
		Depth	mm	420	422				
Weight	Unit	kg	60	70		78			
	Packed unit	kg	64	78	79	87			
Packing	Weight	kg	4	9					
Heat exchanger	Fin	Type			WF fin				
	Treatment		Anti-corrosion treatment (PE)						
Fan	Type				Propeller				
	Discharge direction				Horizontal				
	Quantity				1				
	Air flow rate	Cooling	Nom.	m ³ /min	56	69	71	76	
Heating			Nom.	m ³ /min	50	82			
		Partial	m ³ /min		-	55 (1)			
Fan motor	Quantity				1				
	Model				Brushless DC motor				
	Output	W	94	200					
	Drive				Direct drive				
Compressor	Quantity				1				
	Type				Hermetically sealed swing compressor				
Operation range	Cooling	Ambient	Min.	°CDB	-15				
			Max.	°CDB	46				
	Heating	Ambient	Min.	°CWB	-15				
			Max.	°CWB	15.5				
Sound power level	Cooling		dBA	65	70	71	73		
	Heating		dBA	-		71 (1)	73 (1)		
Sound pressure level	Cooling	Nom.	dBA	46	53		54		
	Heating	Nom.	dBA	47	57				
Refrigerant	Type				R-32				
	Charge	kg	2.45	2.60		2.90			
	Charge	TCO2Eq	1.65	1.76		1.96			
Refrigerant	Control				Expansion valve (electronic type)				
	GWP				675				
	Circuits	Quantity	1						
Refrigerant oil	Type				FW68DA				
	Charged volume	l	0.90		1.35				
Piping connections	Liquid	Quantity		1					
		Type		Flare connection					
		OD	mm	9.52					
	Gas	Quantity		1					
		Type		Flare connection					
		OD	mm	15.9					
	Drain	Quantity		3	5				
		Type		Hole					
	Piping length	OU - IU	Min.	m	5				
			Max.	m	50				
		System	Equivalent	m	70				
			Chargeless	m	30				
		Additional refrigerant charge		kg/m	See installation manual				
		Level difference	IU - OU	Max.	m	30.0			
Level difference	IU - IU		m	0.5					
Heat insulation				Both liquid and gas pipes					
Defrost control				Sensor for outdoor heat exchanger temperature					
Capacity control	Method			Inverter controlled					
PED	Category			Category II					
Safety devices	Item	01	High pressure switch						
		02	Low pressure switch						
	03	Fan driver overload protector							
	04	Fuse							
	05	Compressor motor thermal protector							

Standard accessories: Tie-wraps; Quantity: 2;

Standard accessories: Installation manual; Quantity: 1;

Standard accessories: Refrigerant label for F-gas regulation; Quantity: 1;

Standard accessories: General safety precautions; Quantity: 1;

Standard accessories: LOT10 Energy Label; Quantity: 1;

2 Specifications

1 - 1 RZASG-MV1

Standard accessories: Peel off F-gas label; Quantity: 1;

2

Electrical Specifications			RZASG71MV1	RZASG100MV1	RZASG125MV1	RZASG140MV1
Power supply	Name		V1			
	Phase		1~			
	Frequency	Hz	50			
	Voltage	V	220-240			
	Voltage range	V	198 264			
Current	Zmax	List	Complies to EN61000-3-11			
	Minimum Ssc value	kVa	Equipment complying with EN / IEC 61000-3-12/ See note 2 / See note 3			
Wiring connections	For power supply	Remark	See installation manual outdoor unit			
	For connection with indoor	Remark	See installation manual outdoor unit			
Power supply intake			See installation manual outdoor unit			
Current - 50Hz	Maximum fuse amps (MFA)	A	20	25		32

(1)According to ENER Lot 21 |

European/international technical standard setting the limits for harmonic currents produced by equipment connected to public low-voltage system with input current larger than 16A and ≤ 75A per phase. |

Ssc: Short-circuit power |

European/international technical standard setting the limits for harmonic currents produced by equipment connected to public low-voltage system with input current ≤ 16A per phase.

Technical specifications			FCAG71B + RZASG71MV1	FCAG100B + RZASG100MV1	FCAG125B + RZASG125MV1	FCAG140B + RZASG140MV1		
Cooling capacity	Nom.	kW	6.80 (1)	9.50 (1)	12.1 (1)	13.4 (1)		
Heating capacity	Nom.	kW	7.50 (2)	10.8 (2)	13.5 (2)	15.5 (2)		
Space cooling	Energy efficiency class		A++			-		
	Capacity Pdesign	kW	6.80	9.50	12.1	13.4		
	SEER		6.47	6.55	5.76	6.53		
	ηs,c	%		-	227	258		
	Annual energy consumption	kWh/a	368	507	1,261	1,231		
Space heating (Average climate)	Energy efficiency class		A+			-		
	Capacity Pdesign	kW	4.50		6.00	7.80		
	SCOP/A		4.10	4.17	4.05	4.31		
	SCOPnet/A		4.10	4.17	4.05	4.31		
	ηs,h	%		-	159	169		
	Annual energy consumption	kWh/a	1,537	2,016	2,074	2,534		
	Required back up heating cap at design conditions	kW			0.00			
Space cooling	A Condi- tion (35°C - 27/19)	Pdc EERd	kW	6.80 3.14	9.50 3.26	12.10 2.44	13.40 2.75	
		Power input	kW	2.17	2.92	4.95	4.88	
	B Condi- tion (30°C - 27/19)	Pdc EERd	kW	5.10 4.91	7.00 5.49	8.92 4.30	9.88 4.88	
		Power input	kW	1.04	1.28	2.07	2.03	
	C Condi- tion (25°C - 27/19)	Pdc EERd	kW	3.40 8.43	4.50 7.77	5.74 6.74	6.35 7.69	
		Power input	kW	0.40	0.58	0.85	0.83	
	D Condi- tion (20°C - 27/19)	Pdc EERd	kW	2.89 12.54	3.11 11.16	3.18 10.49	3.74 12.01	
		Power input	kW	0.23	0.28	0.30	0.31	
	Space heating (Average climate)	TOL	Tol (temperature operating limit)	°C	-10			
			Pdh (declared heating cap)	kW	4.50		6.00	7.80
			COPd (declared COP)		2.37	2.52	2.59	2.26
			Power input	kW	1.90	2.38	2.32	3.44
TBivalent		Tbiv (bivalent temperature)	°C	-10				
		Pdh (declared heating cap)	kW	4.50		6.00	7.80	
		COPd (declared COP)		2.37	2.52	2.59	2.26	
		Power input	kW	1.90	2.38	2.32	3.44	
		Pdh (declared heating cap)	kW	3.98	5.31	5.30	6.90	
		COPd (declared COP)		2.37	2.75	2.78	2.60	
Space heating (Average climate)		A Condi- tion (-7°C)	Power input	kW	1.68	1.93	1.91	2.65
		B Condi- tion (2°C)	Pdh (declared heating cap)	kW	2.42		3.23	4.20
		COPd (declared COP)		4.21	3.97	3.88	4.32	
		Power input	kW	0.58	0.81	0.83	0.97	
	C Condi- tion (7°C)	Pdh (declared heating cap)	kW	1.92	2.10	2.13	3.40	
		COPd (declared COP)		5.46	5.58	5.20	5.92	
		Power input	kW	0.35	0.38	0.41	0.57	
	D Con- dition (12°C)	Pdh (declared heating cap)	kW	2.29	2.50	2.55	3.99	
		COPd (declared COP)		6.91	6.95	6.66	7.26	
		Power input	kW	0.33	0.36	0.38	0.55	

2 Specifications

1 - 1 RZASG-MV1

Technical specifications					FCAG71B + RZASG71MV1	FCAG100B + RZASG100MV1	FCAG125B + RZASG125MV1	FCAG140B + RZASG140MV1
Power consumption in other than active mode	Crank-case heater mode	Cooling	PCK	kW			0.000	
		Heating	PCK	kW			0.000	
	Off mode	Cooling	POFF	kW			0.012	
		Heating	POFF	kW			0.012	
	Standby mode	Cooling	PSB	kW			0.012	
		Heating	PSB	kW			0.012	
	Thermo-stat-off mode	Cooling	PTO	kW			0.000	
		Heating	PTO	kW			0.012	
Indication if the heater is equipped with a supplementary heater (pair application)					-			No
Supplementary heater (pair application)					-			0.0
Cooling Cdc (Degradation cooling)							0.25	
Heating Cdh (Degradation heating)							0.25	
Cooling function included							Yes	
Heating function included							Yes	
Average climate included							Yes	
Cold season included							No	
Warm season included							No	
Ecolabel logo							No	

(1)Nominal cooling capacities are based on: indoor temperature: 27°CDB, 19°CWB, outdoor temperature: 35°CDB, equivalent refrigerant piping: 5m, level difference: 0m. |

(2)Nominal heating capacities are based on: indoor temperature: 20°CDB, outdoor temperature: 7°CDB, 6°CWB, equivalent refrigerant piping: 5m, level difference: 0m. |

See separate drawing for operation range |

See separate drawing for electrical data

Technical specifications					FBA71A9 + RZASG71MV1	FBA100A + RZASG100MV1	FBA125A + RZASG125MV1	FBA140A + RZASG140MV1	
Cooling capacity	Nom.			kW	6.80 (1)	9.50 (1)	12.1 (1)	13.4 (1)	
Heating capacity	Nom.			kW	7.50 (2)	10.8 (2)	13.5 (2)	15.5 (2)	
Space cooling	Energy efficiency class				A++	A+	-	-	
	Capacity	Pdesign		kW	6.80	9.50	12.1	13.4	
	SEER				6.19	5.83	5.49	5.81	
	ηs,c			%	-	-	217	229	
	Annual energy consumption			kWh/a	385	570	1,322	1,384	
Space heating (Average climate)	Energy efficiency class				A+	A	-	-	
	Capacity	Pdesign		kW	4.50	6.00		7.80	
	SCOP/A				4.01	3.85	3.63	3.85	
	SCOPnet/A				4.01	3.85	3.63	3.85	
	ηs,h			%	-	-	142	151	
	Annual energy consumption			kWh/a	1,571	2,182	2,314	2,836	
	Required back up heating cap at design conditions			kW			0.00		
Space cooling	A Condi- tion (35°C - 27/19)	Pdc		kW	6.80	9.50	12.10	13.40	
		EERd			3.60	3.20	2.61	2.81	
	B Condi- tion (30°C - 27/19)	Pdc		kW	5.02	7.00	8.92	9.88	
		EERd			5.30	5.13	4.34	4.66	
	C Condi- tion (25°C - 27/19)	Pdc		kW	0.95	1.36	2.06	2.12	
		EERd			3.23	4.50	5.74	6.35	
	D Condi- tion (20°C - 27/19)	Pdc		kW	7.84	7.01	6.36	6.84	
		EERd			2.92	3.10	3.17	3.97	
		Pdc		kW	0.41	0.64	0.90	0.93	
		EERd			2.92	3.10	3.17	3.97	
		Pdc		kW	2.92	3.10	3.17	3.97	
		EERd			9.87	8.59	8.72	8.83	
	Pdc		kW	0.30		0.36	0.45		
	EERd			0.30		0.36	0.45		
Space heating (Average climate)	TOL	Tol (temperature operating limit)			°C			-10	
		Pdh (declared heating cap)		kW	4.50	6.00		7.80	
		COPd (declared COP)			2.37	2.45	2.50	2.06	
		Power input		kW	1.90	2.45	2.40	3.78	
	TBivalent	Tbiv (bivalent temperature)			°C			-10	
		Pdh (declared heating cap)		kW	4.50	6.00		7.80	
		COPd (declared COP)			2.37	2.45	2.50	2.06	
		Power input		kW	1.90	2.45	2.40	3.78	
	A Con- dition (-7°C)	Pdh (declared heating cap)			kW	3.98	5.31	5.30	6.90
		COPd (declared COP)				2.66	2.69	2.72	2.46

2 Specifications

1 - 1 RZASG-MV1

2

Technical specifications				FBA71A9 + RZASG71MV1	FBA100A + RZASG100MV1	FBA125A + RZASG125MV1	FBA140A + RZASG140MV1	
Space heating (Average climate)	A Con- dition (-7°C)	Power input	kW	1.50	1.97	1.95	2.81	
		B Condi- tion (2°C)	Pdh (declared heating cap) COPd (declared COP)	kW	2.42 4.12	3.23 3.77	4.20 3.53	
	C Condi- tion (7°C)	Power input	kW	0.59	0.86	0.91	1.07	
		Pdh (declared heating cap) COPd (declared COP)	kW	2.06 5.04	2.26 4.83	2.27 4.37	3.50 4.98	
		Power input	kW	0.41	0.47	0.52	0.70	
	D Condi- tion (12°C)	Pdh (declared heating cap) COPd (declared COP)	kW	2.43 6.19	2.57 5.70	2.66 5.36	4.10 6.10	
		Power input	kW	0.39	0.45	0.50	0.67	
	Power consump- tion in other than active mode	Crank- case heater mode	Cooling PCK	kW			0.000	
			Heating PCK	kW			0.000	
		Off mode	Cooling POFF	kW			0.014	
Heating POFF			kW			0.014		
Standby mode		Cooling PSB	kW			0.014		
		Heating PSB	kW			0.014		
Thermo- stat-off mode		Cooling PTO	kW			0.000		
		Heating PTO	kW			0.014		
Indication if the heater is equipped with a supplementary heater (pair application)				-		No		
Supplementary heater (pair appli- cation)	Back-up capacity	Heating elbu	kW		-		0.0	
Cooling	Cdc (Degradation cooling)					0.25		
Heating	Cdh (Degradation heating)					0.25		
Cooling function included						Yes		
Heating function included						Yes		
Average climate included						Yes		
Cold season included						No		
Warm season included						No		
Ecolabel logo						No		

(1)Nominal cooling capacities are based on: indoor temperature: 27°CDB, 19°CWB, outdoor temperature: 35°CDB, equivalent refrigerant piping: 5m, level difference: 0m. |

(2)Nominal heating capacities are based on: indoor temperature: 20°CDB, outdoor temperature: 7°CDB, 6°CWB, equivalent refrigerant piping: 5m, level difference: 0m. |

See separate drawing for operation range |

See separate drawing for electrical data

Technical specifications				FDA125A + RZASG125MV1	
Cooling capacity	Nom.		kW	12.1 (1)	
Heating capacity	Nom.		kW	13.5 (2)	
Space cooling	Capacity Pdesign		kW	12.1	
	SEER			5.03	
	ηs,c		%	198	
	Annual energy consumption		kWh/a	1,444	
Space heating (Average climate)	Capacity Pdesign		kW	6.00	
	SCOP/A			3.58	
	SCOPnet/A			3.58	
	ηs,h		%	140	
	Annual energy consumption		kWh/a	2,346	
	Required back up heating cap at design conditions		kW		0.00
Space cooling	A Condi- tion (35°C - 27/19)	Pdc	kW	12.10	
		EERd		2.56	
	B Condi- tion (30°C - 27/19)	Pdc	kW	8.92	
		EERd		4.03	
	C Condi- tion (25°C - 27/19)	Pdc	kW	5.74	
		EERd		5.89	
	D Condi- tion (20°C - 27/19)	Pdc	kW	0.97	
		EERd		3.10	
				kW	7.31
				kW	0.42

2 Specifications

1 - 1 RZASG-MV1

Technical specifications				FDA125A + RZASG125MV1	
Space heating (Average climate)	TOL	Tol (temperature operating limit) °C		-10	
		Pdh (declared heating cap) kW		6.00	
		COPd (declared COP)		2.54	
	Power input kW		2.36		
	TBivalent	Tbiv (bivalent temperature) °C		-10	
		Pdh (declared heating cap) kW		6.00	
		COPd (declared COP)		2.54	
	Power input kW		2.36		
	A Con- dition (-7°C)	Pdh (declared heating cap) kW		5.30	
		COPd (declared COP)		2.76	
Power input kW		1.92			
B Condi- tion (2°C)	Pdh (declared heating cap) kW		3.23		
	COPd (declared COP)		3.54		
	Power input kW		0.91		
Space heating (Average climate)	C Condi- tion (7°C)	Pdh (declared heating cap) kW		2.29	
		COPd (declared COP)		4.27	
		Power input kW		0.54	
	D Con- dition (12°C)	Pdh (declared heating cap) kW		2.65	
		COPd (declared COP)		5.00	
		Power input kW		0.53	
Power consump- tion in other than active mode	Crank- case heater mode	Cooling PCK kW	0.000		
		Heating PCK kW	0.000		
	Off mode	Cooling POFF kW	0.015		
		Heating POFF kW	0.015		
	Standby mode	Cooling PSB kW	0.015		
		Heating PSB kW	0.015		
	Thermo- stat-off mode	Cooling PTO kW	0.000		
		Heating PTO kW	0.015		
	Indication if the heater is equipped with a supplementary heater (pair application)				No
	Supplementary heater (pair appli- cation)	Back-up capacity	Heating elbu kW	0.0	
Cooling	Cdc (Degradation cooling)		0.25		
Heating	Cdh (Degradation heating)		0.25		
Cooling function included				Yes	
Heating function included				Yes	
Average climate included				Yes	
Cold season included				No	
Warm season included				No	
Ecolabel logo				No	

(1)Nominal cooling capacities are based on: indoor temperature: 27°CDB, 19°CWB, outdoor temperature: 35°CDB, equivalent refrigerant piping: 5m, level difference: 0m. |

(2)Nominal heating capacities are based on: indoor temperature: 20°CDB, outdoor temperature: 7°CDB, 6°CWB, equivalent refrigerant piping: 5m, level difference: 0m. |

See separate drawing for operation range |

See separate drawing for electrical data

Technical specifications			FHA71A9 + RZASG71MV1	FHA100A + RZASG100MV1	FHA125A + RZASG125MV1	FHA140A + RZASG140MV1
Cooling capacity	Nom.	kW	6.80 (1)	9.50 (1)	12.1 (1)	13.4 (1)
Heating capacity	Nom.	kW	7.50 (2)	10.8 (2)	13.5 (2)	15.5 (2)
Space cooling	Energy efficiency class		A+		-	
	Capacity	Pdesign kW	6.80	9.50	12.1	13.4
	SEER		5.95	5.83		5.88
	ηs,c %		-		230	232
	Annual energy consumption kWh/a		400	570	1,246	1,368
Space heating (Average climate)	Energy efficiency class		A		-	
	Capacity	Pdesign kW	4.50	6.00	7.80	
	SCOP/A		3.90	3.91	3.83	3.81
	SCOPnet/A		3.90	3.91	3.83	3.81
	ηs,h %		-		150	149
	Annual energy consumption kWh/a		1,616	2,148	2,193	2,866
	Required back up heating cap at design conditions kW		0.00			

2 Specifications

1 - 1 RZASG-MV1

2

Technical specifications				FHA71A9 + RZASG71MV1	FHA100A + RZASG100MV1	FHA125A + RZASG125MV1	FHA140A + RZASG140MV1	
Space cooling	A Condi- tion (35°C - 27/19)	Pdc	kW	6.80	9.50	12.10	13.40	
		EERd		3.81	3.20	2.63	2.77	
	B Condi- tion (30°C - 27/19)	Power input	kW	1.78	2.97	4.60	4.84	
		Pdc	kW	5.02	7.00	8.92	9.88	
	C Condi- tion (25°C - 27/19)	EERd		4.84	4.91	4.53	4.59	
		Power input	kW	1.04	1.43	1.97	2.15	
	D Condi- tion (20°C - 27/19)	Pdc	kW	3.28	4.50	5.74	6.35	
		EERd		7.45	6.98	6.79	6.85	
		Power input	kW	0.44	0.64	0.85	0.93	
		EERd		3.39	3.10	3.17	3.86	
		Power input	kW	9.41	8.87	9.62	9.50	
		Power input	kW	0.36	0.35	0.33	0.41	
Space heating (Average climate)	TOL	Tol (temperature operating limit) °C		-10				
		Pdh (declared heating cap)	kW	4.50	6.00	7.80		
		COPd (declared COP)		2.21	2.49	1.98		
		Power input	kW	2.04	2.41	3.95		
	TBivalent	Tbiv (bivalent temperature) °C		-10				
		Pdh (declared heating cap)	kW	4.50	6.00	7.80		
		COPd (declared COP)		2.21	2.49	1.98		
		Power input	kW	2.04	2.41	3.95		
	A Con- dition (-7°C)	Pdh (declared heating cap)	kW	3.98	5.31	5.30	6.90	
		COPd (declared COP)		2.48	2.73	2.72	2.37	
	Space heating (Average climate)	A Con- dition (-7°C)	Power input	kW	1.61	1.94	1.95	2.91
			Pdh (declared heating cap)	kW	2.42	3.23	4.20	
B Condi- tion (2°C)		COPd (declared COP)		3.89	3.77	3.68	3.92	
		Power input	kW	0.62	0.86	0.88	1.07	
C Condi- tion (7°C)		Pdh (declared heating cap)	kW	2.04	2.18	2.19	3.45	
		COPd (declared COP)		5.22	4.96	4.84	4.95	
		Power input	kW	0.39	0.44	0.45	0.70	
		Pdh (declared heating cap)	kW	2.41	2.57	2.58	4.05	
D Con- dition (12°C)		COPd (declared COP)		6.57	6.14	6.00	6.07	
		Power input	kW	0.37	0.42	0.43	0.67	
Power consump- tion in other than active mode		Crank- case heater mode	Cooling PCK	kW	0.000			
			Heating PCK	kW	0.000			
	Off mode	Cooling POFF	kW	0.012				
		Heating POFF	kW	0.012				
	Standby mode	Cooling PSB	kW	0.012				
		Heating PSB	kW	0.012				
	Thermo- stat-off mode	Cooling PTO	kW	0.000				
		Heating PTO	kW	0.012				
	Indication if the heater is equipped with a supplementary heater (pair application)				-			No
	Supplementary heater (pair application)				-			0.0
	Cooling	Cdc (Degradation cooling)			0.25			
	Heating	Cdh (Degradation heating)			0.25			
Cooling function included				Yes				
Heating function included				Yes				
Average climate included				Yes				
Cold season included				No				
Warm season included				No				
Ecolabel logo				No				

(1)Nominal cooling capacities are based on: indoor temperature: 27°CDB, 19°CWB, outdoor temperature: 35°CDB, equivalent refrigerant piping: 5m, level difference: 0m. |

(2)Nominal heating capacities are based on: indoor temperature: 20°CDB, outdoor temperature: 7°CDB, 6°CWB, equivalent refrigerant piping: 5m, level difference: 0m. |

See separate drawing for operation range |

See separate drawing for electrical data

Technical specifications				FUA71A + RZASG71MV1	FUA100A + RZASG100MV1	FUA125A + RZASG125MV1
Cooling capacity	Nom.	kW	6.80 (1)	9.50 (1)	12.1 (1)	
Heating capacity	Nom.	kW	7.50 (2)	10.8 (2)	13.5 (2)	

2 Specifications

1 - 1 RZASG-MV1

Technical specifications				FUA71A + RZASG71MV1	FUA100A + RZASG100MV1	FUA125A + RZASG125MV1		
Space cooling	Energy efficiency class			A++	A+	-		
	Capacity	Pdesign	kW	6.80	9.50	12.1		
	SEER			6.16	5.83	5.49		
	ηs,c			%	-	217		
	Annual energy consumption			kWh/a	386	570	1,322	
Space heating (Average climate)	Energy efficiency class			A	A+	-		
	Capacity	Pdesign	kW	4.50	6.00			
	SCOP/A			3.90	4.01	3.84		
	SCOPnet/A			3.90	4.01	3.84		
	ηs,h			%	-	151		
	Annual energy consumption			kWh/a	1,615	2,095	2,188	
Required back up heating cap at design conditions			kW	0.00				
Space cooling	A Condi- tion (35°C -27/19)	Pdc	kW	6.80	9.50	12.10		
		EERd		3.84	3.20	2.35		
	B Condi- tion (30°C -27/19)	Pdc	kW	5.02	7.00	8.92		
		EERd		4.98	4.81	4.24		
	C Condi- tion (25°C -27/19)	Pdc	kW	3.23	4.50	5.74		
		EERd		7.82	7.04	6.48		
	D Condi- tion (20°C -27/19)	Pdc	kW	3.04	3.10	3.14		
		EERd		9.69	8.98	9.22		
	Power input			kW	0.31	0.35	0.34	
	Space heating (Average climate)	TOL	Tol (temperature operating limit)		°C	-10		
			Pdh (declared heating cap)	kW	4.50	6.00		
			COPd (declared COP)		2.23	2.56	2.52	
		Power input			kW	2.01	2.35	2.38
TBivalent		Tbiv (bivalent temperature)		°C	-10			
		Pdh (declared heating cap)	kW	4.50	6.00			
		COPd (declared COP)		2.23	2.56	2.52		
Power input			kW	2.01	2.35	2.38		
A Condi- tion (-7°C)		Pdh (declared heating cap)	kW	3.98	5.31	5.30		
		COPd (declared COP)		2.51	2.79	2.76		
Space heating (Average climate)		A Condi- tion (-7°C)	Power input		kW	1.59	1.90	1.92
			B Condi- tion (2°C)	Pdh (declared heating cap)	kW	2.42	3.23	
	COPd (declared COP)			3.90	3.87	3.70		
	Power input			kW	0.62	0.83	0.87	
	C Condi- tion (7°C)	Pdh (declared heating cap)	kW	2.07	2.19	2.21		
		COPd (declared COP)		5.17	5.10	4.81		
Power input			kW	0.40	0.43	0.46		
D Condi- tion (12°C)	Pdh (declared heating cap)	kW	2.44	2.57	2.59			
	COPd (declared COP)		6.56	6.26	5.89			
Power input			kW	0.37	0.41	0.44		
Power consumption in other than active mode	Crank-case heater mode	Cooling	PCK	kW	0.000			
		Heating	PCK	kW	0.000			
	Off mode	Cooling	POFF	kW	0.012			
		Heating	POFF	kW	0.012			
	Standby mode	Cooling	PSB	kW	0.012			
		Heating	PSB	kW	0.012			
	Thermostat-off mode	Cooling	PTO	kW	0.000			
		Heating	PTO	kW	0.012			
	Indication if the heater is equipped with a supplementary heater (pair application)				-		No	
	Supplementary heater (pair application)		Back-up capacity	Heating elbu	kW	-	0.0	
Cooling	Cdc (Degradation cooling)			0.25				
Heating	Cdh (Degradation heating)			0.25				
Cooling function included				Yes				
Heating function included				Yes				
Average climate included				Yes				
Cold season included				No				
Warm season included				No				

2 Specifications

1 - 1 RZASG-MV1

2

Technical specifications				FUA71A + RZASG71MV1	FUA100A + RZASG100MV1	FUA125A + RZASG125MV1	
Ecolabel logo				No			
(1)Nominal cooling capacities are based on: indoor temperature: 27°CDB, 19°CWB, outdoor temperature: 35°CDB, equivalent refrigerant piping: 5m, level difference: 0m.							
(2)Nominal heating capacities are based on: indoor temperature: 20°CDB, outdoor temperature: 7°CDB, 6°CWB, equivalent refrigerant piping: 5m, level difference: 0m.							
See separate drawing for operation range							
See separate drawing for electrical data							
Technical specifications				FAA71B + RZASG71MV1	FAA100B + RZASG100MV1		
Cooling capacity	Nom.	kW		6.80 (1)		9.50 (1)	
Heating capacity	Nom.	kW		7.50 (2)		10.8 (2)	
Space cooling	Energy efficiency class			A++		A+	
	Capacity Pdesign	kW		6.80		9.50	
	SEER			6.41		5.83	
	Annual energy consumption	kWh/a		371		570	
Space heating (Average climate)	Energy efficiency class				A		
	Capacity Pdesign	kW		4.50		6.00	
	SCOP/A			3.90		3.85	
	SCOPnet/A			3.90		3.85	
Space cooling	Annual energy consumption	kWh/a		1,615		2,182	
	Required back up heating cap at design conditions	kW			0.00		
	A Condi- tion (35°C - 27/19)	Pdc	kW		6.80		9.50
		EERd			3.40		2.70
	B Condi- tion (30°C - 27/19)	Pdc	kW		2.00		3.52
		EERd			5.02		7.00
	C Condi- tion (25°C - 27/19)	Pdc	kW		5.30		4.87
		EERd			0.95		1.44
	D Condi- tion (20°C - 27/19)	Pdc	kW		3.23		4.50
		EERd			7.98		6.85
	Space heating (Average climate)	TOL	Pdc	kW			0.66
			EERd				3.00
EERd					11.17		10.23
TBivalent		Power input	kW		0.25		0.29
		Tol (temperature operating limit)	°C			-10	
		Pdh (declared heating cap)	kW		4.50		6.00
A Con- dition (-7°C)		COPd (declared COP)			2.16		2.31
		Power input	kW		2.08		2.60
		Tbiv (bivalent temperature)	°C			-10	
B Condi- tion (2°C)		Pdh (declared heating cap)	kW		4.50		6.00
		COPd (declared COP)			2.16		2.31
		Power input	kW		2.08		2.60
C Condi- tion (7°C)	Pdh (declared heating cap)	kW		3.98		5.31	
	COPd (declared COP)			2.44		2.55	
	Power input	kW		1.63		2.08	
D Con- dition (12°C)	Pdh (declared heating cap)	kW		2.42		3.23	
	COPd (declared COP)			3.90		3.68	
	Power input	kW		0.62		0.88	
Power consump- tion in other than active mode	Crank- case heater mode	COPd (declared COP)		2.02		2.12	
		Power input	kW		5.26		5.09
	Off mode	COPd (declared COP)			0.38		0.42
		Power input	kW		2.39		2.52
	Standby mode	COPd (declared COP)			6.62		6.53
		Power input	kW		0.36		0.39
	Thermo- stat-off mode	Cooling PCK	kW			0.000	
		Heating PCK	kW			0.000	
	Cooling	Cooling POFF	kW			0.012	
		Heating POFF	kW			0.012	
	Heating	Cooling PSB	kW			0.012	
		Heating PSB	kW			0.012	
Cooling function included	Cooling PTO	kW			0.000		
	Heating PTO	kW			0.012		
Heating function included						Yes	
Average climate included						Yes	
Cold season included						No	
Warm season included						No	
Cooling	Cdc (Degradation cooling)					0.25	
Heating	Cdh (Degradation heating)					0.25	

2 Specifications

1 - 1 RZASG-MV1

Technical specifications				FAA71B + RZASG71MV1		FAA100B + RZASG100MV1					
Ecolabel logo				No							
(1)Nominal cooling capacities are based on: indoor temperature: 27°CDB, 19°CWB, outdoor temperature: 35°CDB, equivalent refrigerant piping: 5m, level difference: 0m.											
(2)Nominal heating capacities are based on: indoor temperature: 20°CDB, outdoor temperature: 7°CDB, 6°CWB, equivalent refrigerant piping: 5m, level difference: 0m.											
See separate drawing for operation range											
See separate drawing for electrical data											
Technical specifications				FVA71A + RZASG71MV1		FVA100A + RZASG100MV1		FVA125A + RZASG125MV1		FVA140A + RZASG140MV1	
Cooling capacity	Nom.		kW	6.80 (1)		9.50 (1)		12.1 (1)		13.4 (1)	
Heating capacity	Nom.		kW	7.50 (2)		10.8 (2)		13.5 (2)		15.5 (2)	
Space cooling	Energy efficiency class			A+							
	Capacity	Pdesign	kW	6.80		9.50		12.1		13.4	
	SEER			5.83		5.72		5.52		5.63	
	ηs,c		%	-		-		218		222	
	Annual energy consumption		kWh/a	408		581		1,314		1,428	
Space heating (Average climate)	Energy efficiency class			A+		A		-		-	
	Capacity	Pdesign	kW	4.50		6.00		7.80		-	
	SCOP/A			4.04		3.83		3.64		3.81	
	SCOPnet/A			4.04		3.83		3.64		3.81	
	ηs,h		%	-		-		143		149	
	Annual energy consumption		kWh/a	1,559		2,193		2,308		2,866	
	Required back up heating cap at design conditions		kW	0.00							
Space cooling	A Condi- tion (35°C -27/19)	Pdc	kW	6.80		9.50		12.10		13.40	
		EERd		3.38		3.20		2.47		2.62	
		Power input	kW	2.01		2.97		4.90		5.12	
	B Condi- tion (30°C -27/19)	Pdc	kW	5.02		7.00		8.92		9.88	
		EERd		5.07		5.01		4.31		4.52	
		Power input	kW	0.99		1.40		2.07		2.19	
	C Condi- tion (25°C -27/19)	Pdc	kW	3.23		4.50		5.74		6.35	
		EERd		7.08		6.78		6.26		6.51	
		Power input	kW	0.46		0.66		0.92		0.98	
	D Condi- tion (20°C -27/19)	Pdc	kW	2.77		3.00		3.07		3.76	
		EERd		9.12		8.25		9.54		8.88	
		Power input	kW	0.30		0.36		0.32		0.42	
Space heating (Average climate)	TOL	Tol (temperature operating limit) °C		-10							
		Pdh (declared heating cap)	kW	4.50		6.00		7.80		-	
		COPd (declared COP)		2.26		2.46		2.37		1.99	
		Power input	kW	1.99		2.44		2.53		3.93	
	TBivalent	Tbiv (bivalent temperature) °C		-10							
		Pdh (declared heating cap)	kW	4.50		6.00		7.80		-	
		COPd (declared COP)		2.26		2.46		2.37		1.99	
		Power input	kW	1.99		2.44		2.53		3.93	
	A Condi- tion (-7°C)	Pdh (declared heating cap)	kW	3.98		5.31		5.30		6.90	
		COPd (declared COP)		2.55		2.70		2.60		2.38	
Space heating (Average climate)	A Condi- tion (-7°C)	Power input	kW	1.56		1.97		2.04		2.90	
	B Condi- tion (2°C)	Pdh (declared heating cap)	kW	2.42		3.23		4.20		-	
		COPd (declared COP)		4.05		3.72		3.51		3.90	
		Power input	kW	0.60		0.87		0.92		1.08	
	C Condi- tion (7°C)	Pdh (declared heating cap)	kW	2.01		2.20		2.19		3.47	
		COPd (declared COP)		5.41		4.81		4.57		4.99	
		Power input	kW	0.37		0.46		0.48		0.70	
	D Condi- tion (12°C)	Pdh (declared heating cap)	kW	2.37		2.58		2.57		4.07	
		COPd (declared COP)		6.72		5.82		5.60		6.10	
		Power input	kW	0.35		0.44		0.46		0.67	
Power consumption in other than active mode	Crank-case heater mode	Cooling	PCK	kW		0.000		0.000		0.000	
		Heating	PCK	kW		0.000		0.000		0.000	
	Off mode	Cooling	POFF	kW		0.012		0.012		0.012	
		Heating	POFF	kW		0.012		0.012		0.012	
	Standby mode	Cooling	PSB	kW		0.012		0.012		0.012	
		Heating	PSB	kW		0.012		0.012		0.012	
	Thermo-stat-off mode	Cooling	PTO	kW		0.000		0.000		0.000	
		Heating	PTO	kW		0.012		0.012		0.012	
Indication if the heater is equipped with a supplementary heater (pair application)				-				No			

2 Specifications

1 - 1 RZASG-MV1

2

Technical specifications				FVA71A + RZASG71MV1	FVA100A + RZASG100MV1	FVA125A + RZASG125MV1	FVA140A + RZASG140MV1
Supplementary heater (pair application)	Back-up capacity	Heating elbu	kw	-			0.0
Cooling	Cdc (Degradation cooling)					0.25	
Heating	Cdh (Degradation heating)					0.25	
Cooling function included						Yes	
Heating function included						Yes	
Average climate included						Yes	
Cold season included						No	
Warm season included						No	
Ecolabel logo						No	

(1)Nominal cooling capacities are based on: indoor temperature: 27°CDB, 19°CWB, outdoor temperature: 35°CDB, equivalent refrigerant piping: 5m, level difference: 0m. |

(2)Nominal heating capacities are based on: indoor temperature: 20°CDB, outdoor temperature: 7°CDB, 6°CWB, equivalent refrigerant piping: 5m, level difference: 0m. |

See separate drawing for operation range |

See separate drawing for electrical data

4 Options

4 - 1 Options

4

AZAS-MV1
 AZAS-MY1
 RZAG-MV1
 RZAG-MY1
 RZASG-MV1
 RZASG-MY1

Available options for RZAG models

Option	Option kit			
	RZAG71M7V1B RZAG71M7Y1B	RZAG100M7V1B RZAG100M7Y1B	RZAG125M7V1B RZAG125M7Y1B	RZAG140M7Y1B RZAG140M7V1B
Bottom plate heater	EKBPH140L7			
Refrigerant branch piping	Twin	KHRQ(M)58T		
	Triple	-	KHRQ(M)58H	
	Double twin	-	KHRQ(M)58T (3x)	
Demand adaptor kit	SB.KRP58M52			

Available options for RZASG models

Option	Option kit			
	RZASG71M2V1B	RZASG100M7V1B RZASG100M7Y1B	RZASG125M7V1B RZASG125M7Y1B	RZASG140M7V1B RZASG140M7Y1B
Bottom plate heater	-			
Refrigerant branch piping	Twin	KHRQ(M)58T		
	Triple	-	KHRQ(M)58H	
	Double twin	-	KHRQ(M)58T (3x)	
Demand adaptor kit	SB.KRP58M52			

3D108867

5 Combination table

5 - 1 Combination Table

AZAS-MV1
AZAS-MY1
RZAG-MV1
RZAG-MY1
RZASG-MV1
RZASG-MY1

Possible combinations	71	100	125	140
1= Pair	35+35	50+50	60+60	71+71
2= Twin		35+35+35 (*)	50+50+50 (*)	50+50+50 (*)
3= Triple			35+35+35+35 (*)	
4= Double twin				

(*) : See note 1.

Sky Air	High Cassette				Thin cassette						2x2 cassette		Duct (medium ESP)						Concealed floor standing type		Ceiling-mounted - 4-way blow		Wall mounted type		Duct (high ESP)			
Model	FCAG71HVEB	FCAG100HVEB	FCAG125HVEB	FCAG140HVEB	FCAG50VEB	FCAG60VEB	FCAG70VEB	FCAG100VEB	FCAG125VEB	FCAG140VEB	FFAS3502VEB	FFAS5002VEB	FFAS6002VEB	FFAS7002VEB	FFAS10002VEB	FFAS12502VEB	FFAS14002VEB	FNAS350VEB	FNAS500VEB	FNAS600VEB	FNAS700VEB	FUA100AVEB	FUA125AVEB	FUA140AVEB	FAA100BAUVEB	FAA125BAUVEB	FAA140BAUVEB	
RZAG1M7Y1B	P																											
RZAG100M7Y1B		P																										
RZAG125M7Y1B			P																									
RZAG140M7Y1B				P																								
RZASG1M2Y1B																												
RZASG100M7Y1B																												
RZASG125M7Y1B																												
RZASG140M7Y1B																												
AZAS1M2Y1B																												
AZAS100M7Y1B																												
AZAS125M7Y1B																												
AZAS140M7Y1B																												

Sky Air	Floor standing type				Slim duct				Ceiling-suspended				Duct (medium ESP)			
Model	FVA17AMVEB	FVA100AMVEB	FVA125AMVEB	FVA140AMVEB	FDM35FY1B9	FDM50FY1B9	FDM60FY1B9	FDM70FY1B9	FHA35AVEB9	FHA50AVEB9	FHA60AVEB9	FHA70AVEB9	FHA100AVEB9	ADEA100AVEB	ADEA125AVEB	ADEA140AVEB
RZAG1M7Y1B	P															
RZAG100M7Y1B		P														
RZAG125M7Y1B			P													
RZAG140M7Y1B				P												
RZASG1M2Y1B																
RZASG100M7Y1B																
RZASG125M7Y1B																
RZASG140M7Y1B																
AZAS1M2Y1B																
AZAS100M7Y1B																
AZAS125M7Y1B																
AZAS140M7Y1B																

Notes

- Maximum capacity is limited based on outdoor unit capacity.
- When combining multiple indoor units, designate the unit whose remote controller is equipped with the most functions as the master unit.
- For the selection of the correct refnet kit, required to install a multi-combination, refer to the option list.

Twin : KHRQ(M)S8T
Triple : KHRQ(M)S8H
Double twin : KHRQ(M)S8T

- ADEA*2VEB: can only be used in combination with AZAS*M*Y1B

3D108868E

6 Capacity tables

6 - 2 Capacity Correction Factor

6

RZASG-MV1

RZASG-MY1

Capacity in function of field piping length

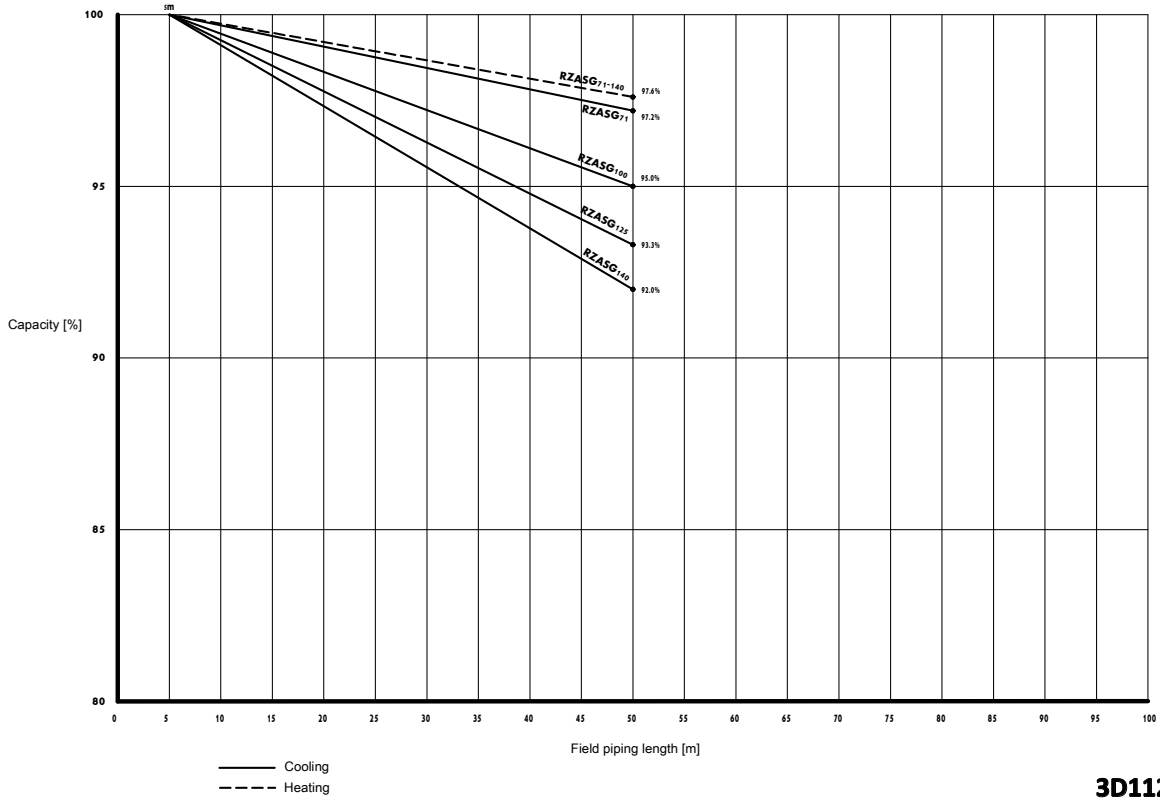

3D112163

7 Dimensional drawings

7 - 1 Dimensional Drawings

AZAS71MV1
RZASG71MV1

4 holes for anchor bolts
M12

- ① Gas pipe connection Ø15.9 flare
- ② Liquid pipe connection Ø9.5 flare
- ③ Service port (in the unit)
- ④ Electronic connection and grounding terminal M5 (in the switch box)
- ⑤ Refrigerant piping intake
- ⑥ Power supply wiring intake (knockout hole Ø34)
- ⑦ Control wiring intake (knockout hole Ø27)
- ⑧ Drain outlet

3D110013

AZAS100-140MV1
AZAS-MY1
RZAG71MV1
RZAG71MY1
RZASG100-140MV1
RZASG-MY1

4 holes for anchor bolts
M12

Model	AA	AB
RZAG71* / RZASG100-125* / AZAS100-125*	331	337
RZASG140* / AZAS140*	414	420

- ① Gas pipe connection Ø15.9 flare
- ② Liquid pipe connection Ø9.5 flare
- ③ Service port (in the unit)
- ④ Electronic connection and grounding terminal M5 (in the switch box)
- ⑤ Refrigerant piping intake
- ⑥ Power supply wiring intake (knockout hole Ø34)
- ⑦ Control wiring intake (knockout hole Ø27)
- ⑧ Drain outlet

3D110011

8 Centre of gravity

8 - 1 Centre of Gravity

AZAS71MV1
RZASG71MV1

8

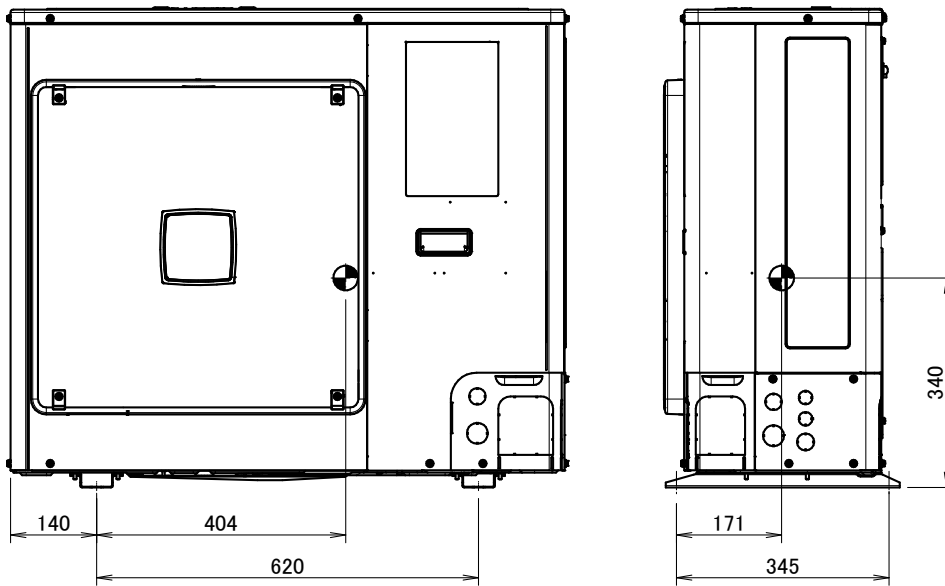

4D110027

8 Centre of gravity

8 - 1 Centre of Gravity

AZAS100-140MV1
AZAS-MY1
RZAG71MV1
RZAG71MY1
RZASG100-140MV1
RZASG-MY1

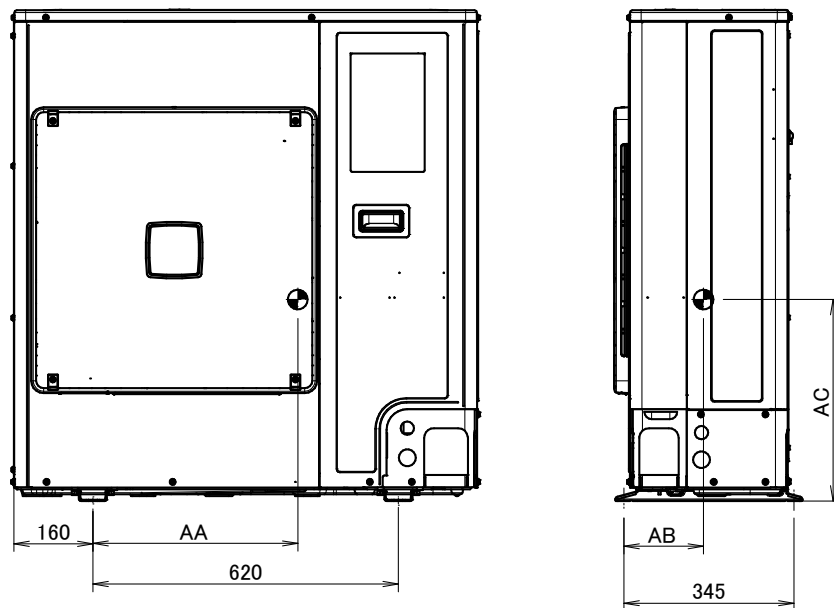

Model	AA	AB	AC
RZAG71M7V*	414	163	407
RZAG71M7Y*	432	137	407
RZASG100-125M7V* / AZAS100-125M7V*	425	181	422
RZASG100-125M7Y* / AZAS100-125M7Y*	414	156	417
RZASG140M7V* / AZAS140M7V*	414	161	423
RZASG140M7Y* / AZAS140M7Y*	416	151	418

4D110025

9 Piping diagrams

9 - 1 Piping Diagrams

9

AZAS-MV1
 AZAS-MY1
 RZAG-MV1
 RZAG-MY1
 RZASG-MV1
 RZASG-MY1

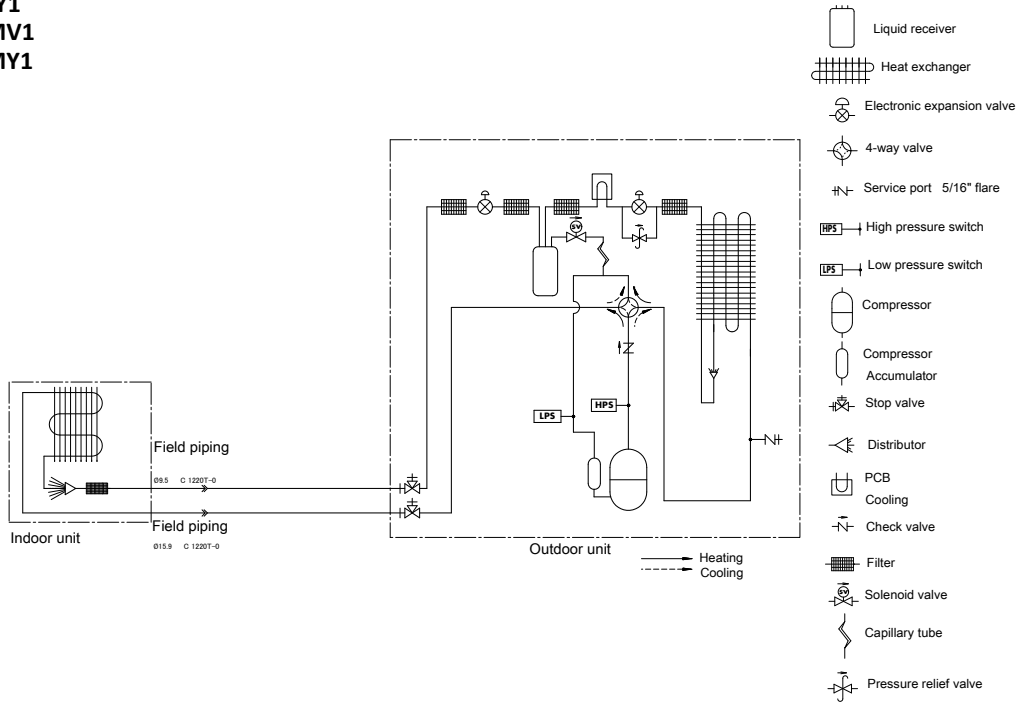

Notes

1. The pipes between the branch and the indoor units should have the same size as the indoor connections.

3D108855A

9 Piping diagrams

9 - 2 Piping Diagram Twin Application

RZAG-MV1
 RZAG-MY1
 RZASG-MV1
 RZASG-MY1

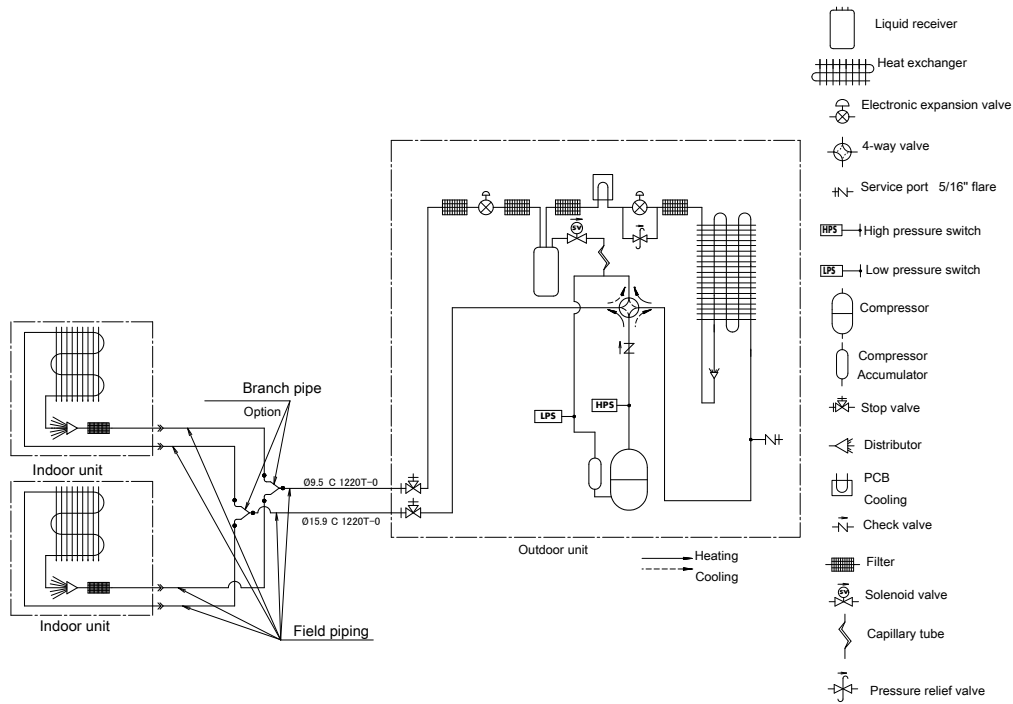

Notes

- 1. The pipes between the branch and the indoor units should have the same size as the indoor connections.

3D108856A

9 Piping diagrams

9 - 3 Piping Diagram Triple Application

9

RZAG100-140MV1
 RZAG100-140MY1
 RZASG100-140MV1
 RZASG-MY1

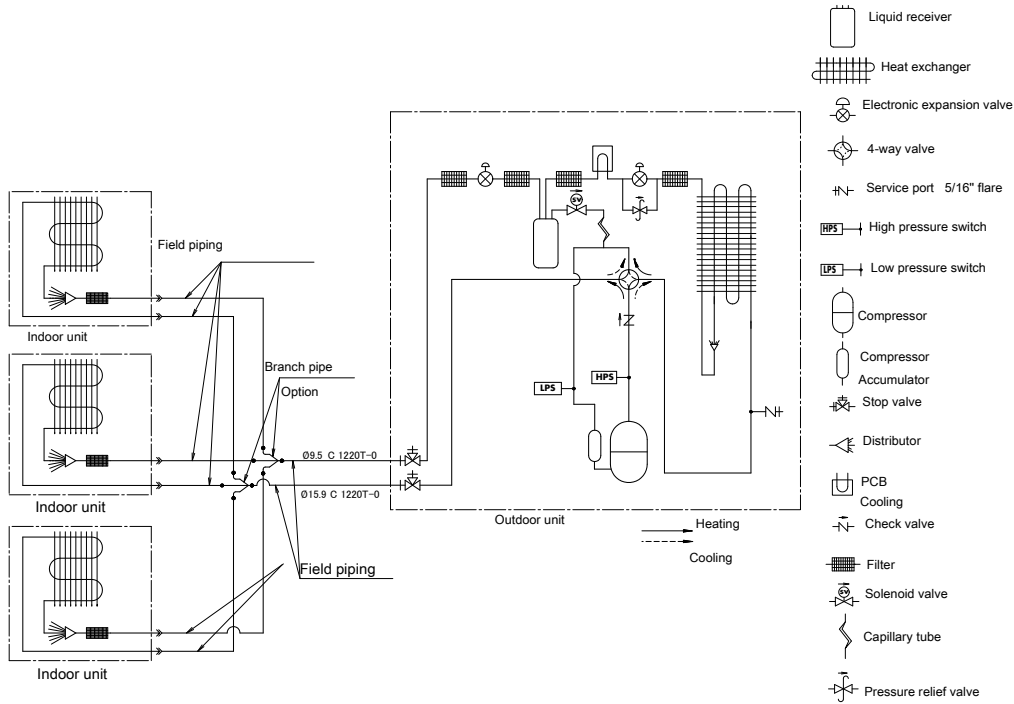

Notes

1. The pipes between the branch and the indoor units should have the same size as the indoor connections.

3D108857A

9 Piping diagrams

9 - 4 Piping Diagram Double Twin Application

RZAG125-140MV1
 RZAG125-140MY1
 RZASG125-140MV1
 RZASG125-140MY1

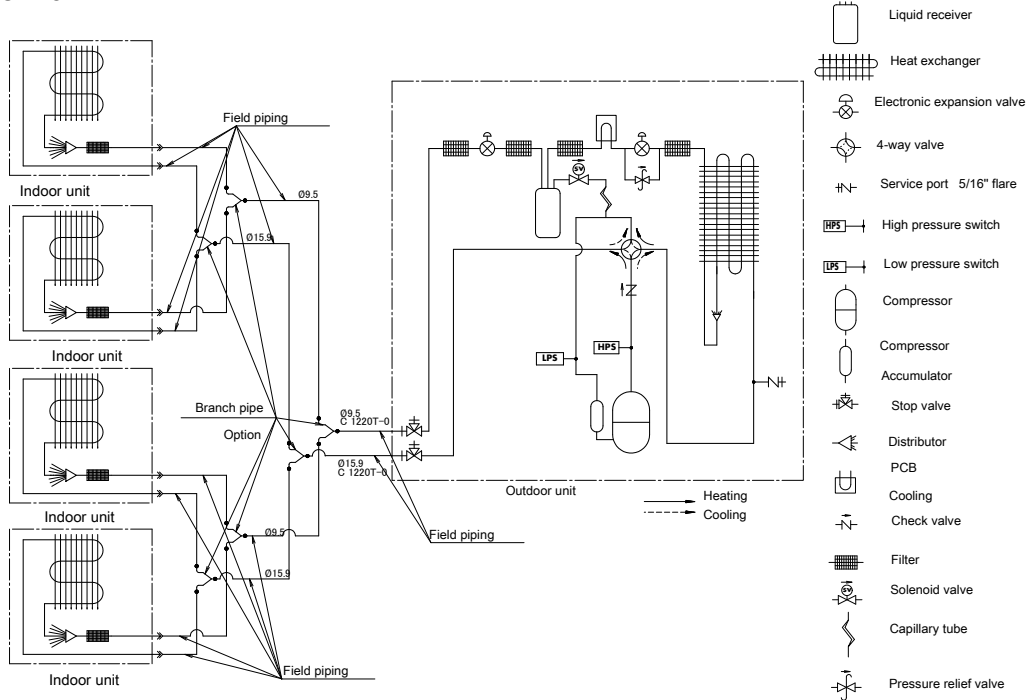

Notes

1. The pipes between the branch and the indoor units should have the same size as the indoor connections.

3D108858A

10 Wiring diagrams

10 - 1 Wiring Diagrams - Single Phase

10

AZAS71MV1
RZASG71MV1

(1) Connection diagram

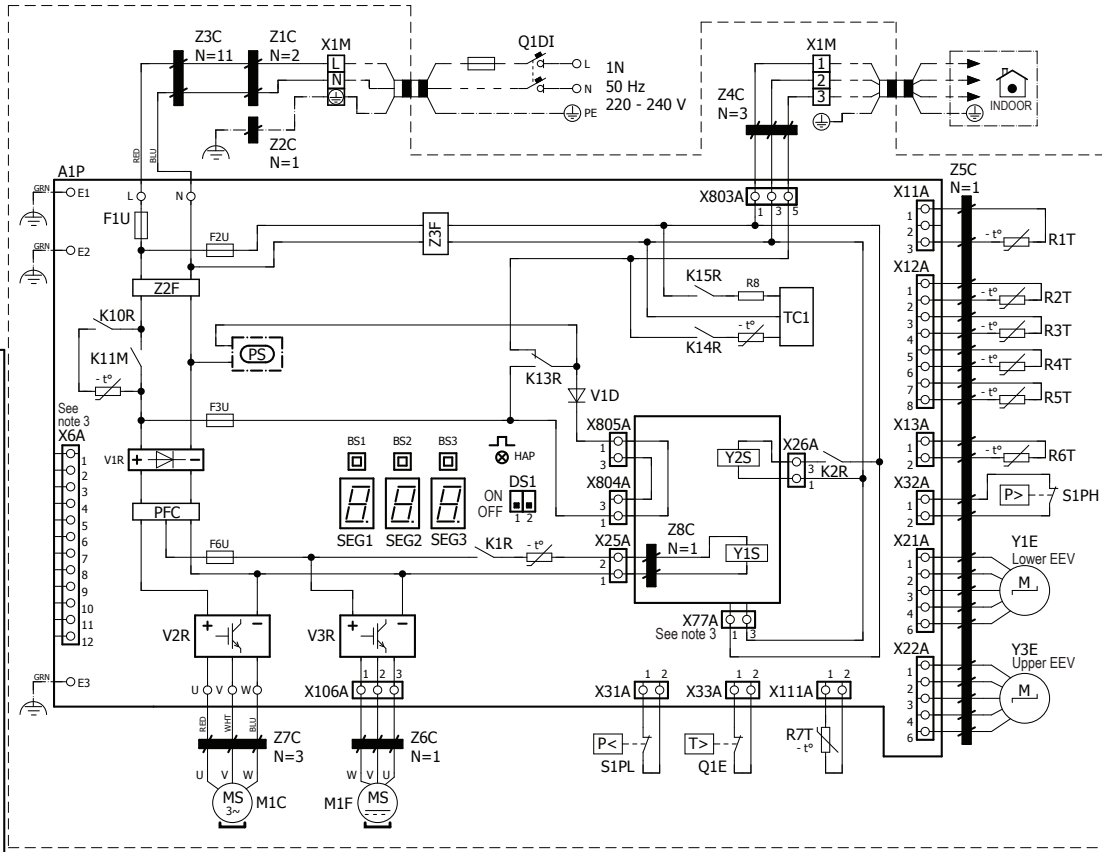

(2) Layout

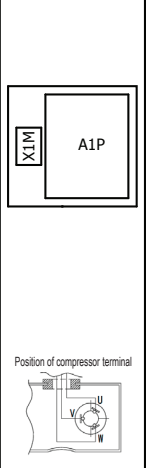

(3) NOTES

- : Connection
- : Earth wiring
- : Field supply
- : Option
- : switch box
- : PCB
- : Wiring depending on model
- : Protective earth
- : Field wire

(4) LEGEND

Part n°	Description
A1P	Printed circuit board (main)
BS1-3 (A1P)	Push-button switch
DS1(A1P)	Dipswitch
E1-3 (A1P)	Connector
F1U (A1P)	Fuse T 31,5 A 250 V
F2U (A1P)	Fuse T 6,3 A 250 V
F3U (A1P)	Fuse T 6,3 A 250 V
F6U (A1P)	Fuse T 5 A 250V
HAP (A1P)	Light-emitting diode (service monitor is green)
K1R (A1P)	Magnetic relay (Y1S)
K2R (A1P)	Magnetic relay (Y2S)
K13-15R, K10R (A1P)	Magnetic relay
K11M (A1P)	Magnetic contactor
L (A1P)	Connector
M1C	Compressor motor
M1F	Fan motor
N (A1P)	Connector
PFC (A1P)	Power factor correction
PS (A1P)	Switching power supply
Q1DI	Earth leakage circuit breaker (30mA)
Q1E	Overload protection

Part n°	Description
R1T	Thermistor (air)
R2T	Thermistor (discharge)
R3T	Thermistor (suction)
R4T	Thermistor (heat exchanger)
R5T	Thermistor (heat exchanger middle)
R6T	Thermistor (liquid)
R7T	Thermistor (fin)
R8 (A1P)	Resistor
S1PH	High pressure switch
S1PL	Low pressure switch
SEG1-3 (A1P)	7-segment display
TC1 (A1P)	Signal transceiver circuit
U, V, W (A1P)	Connector
V1D (A1P)	Diode
V*R (A1P)	Diode module
X*A (A1P)	Connector
X1M	Terminal strip
Y1E, Y3E	Electronic expansion valve
Y1-2S	Solenoid valve (4-way valve)
Z*C	Noise filter (ferrite core)
Z*F (A1P)	Noise filter

* : optional
: field supply

NOTES

- Refer to the wiring diagram sticker (on the back of the front plate) for how to use the BS1-BS3 and DS1 switches.
- When operating, do not short-circuit protection device(s) S1PH, S1PL and Q1E.
- Refer to the combination table and the option manual for how to connect the wiring to X6A and X77A.
- Colours: BLK:black; RED:red; BLU:blue; WHT:white; GRN:green

4D110098A

10 Wiring diagrams

10 - 1 Wiring Diagrams - Single Phase

AZAS100MV1
RZAG71MV1
RZASG100MV1

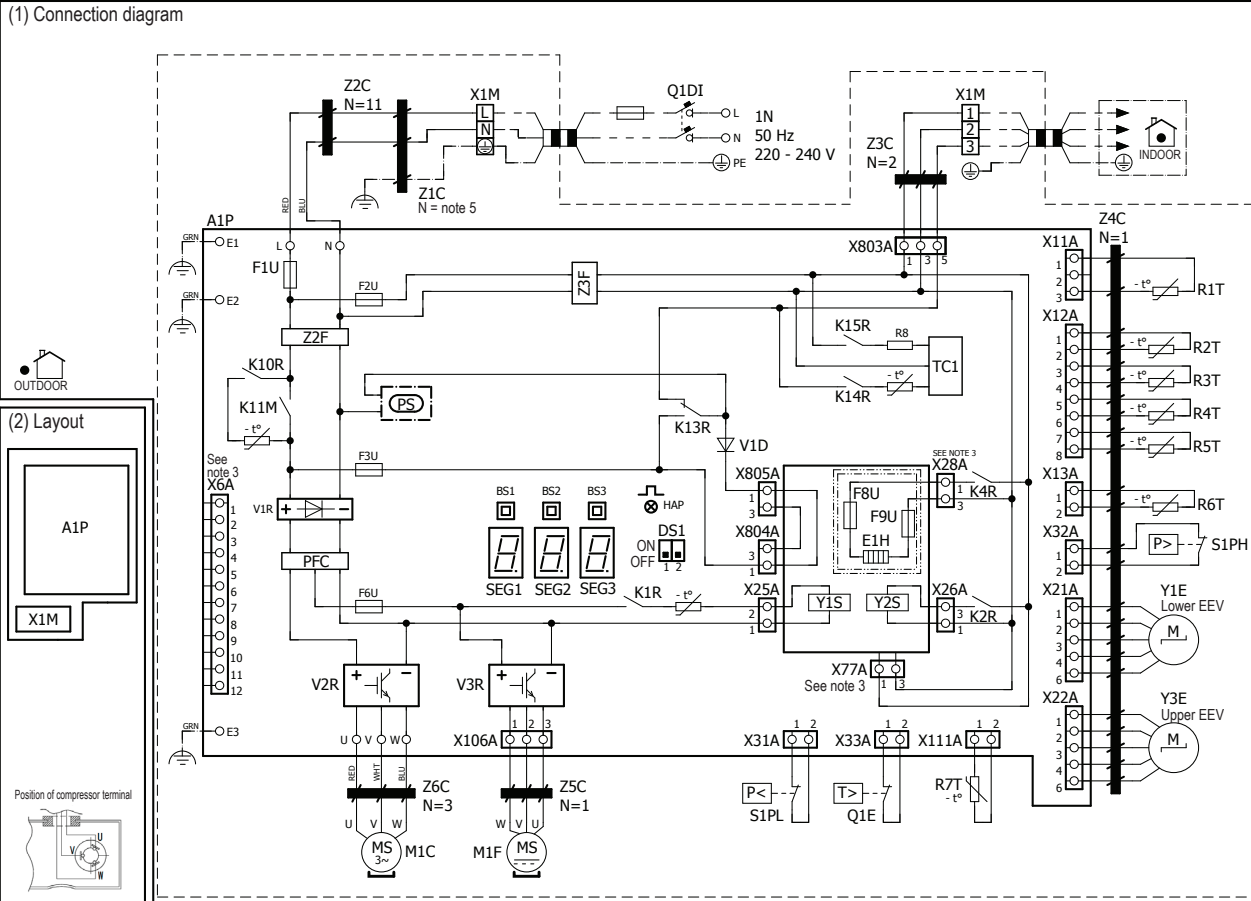

- (3) NOTES**
- ⬤ : Connection
 - X1M : Main terminal
 - : Earth wiring
 - : Field supply
 - ⋯ : Option
 - : switch box
 - ▭ : PCB
 - ⋯ : Wiring depending on model
 - ⊕ : Protective earth
 - ⎓ : Field wire

(4) LEGEND

Part n°	Description
A1P	Printed circuit board (main)
BS1-3 (A1P)	Push-button switch
DS1(A1P)	Dipswitch
E1-3 (A1P)	Connector
E1H	* Bottom plate heater
F1U (A1P)	Fuse T 31,5 A 250 V
F2U (A1P)	Fuse T 6,3 A 250 V
F3U (A1P)	Fuse T 6,3 A 250 V
F6U (A1P)	Fuse T 5 A 250V
F8-9U	* Fuse F 1 A 250 V
HAP (A1P)	Light-emitting diode (service monitor is green)
K1R (A1P)	Magnetic relay (Y1S)
K2R (A1P)	Magnetic relay (Y2S)
K4R (A1P)	Magnetic relay (E1H)
K13-15R, K10R (A1P)	Magnetic relay
K11M (A1P)	Magnetic contactor
L (A1P)	Connector
M1C	Compressor motor
M1F	Fan motor
N (A1P)	Connector
PFC (A1P)	Power factor correction
PS (A1P)	Switching power supply
Q1DI	Earth leakage circuit breaker (30mA)

Part n°	Description
Q1E	Overload protection
R1T	Thermistor (air)
R2T	Thermistor (discharge)
R3T	Thermistor (suction)
R4T	Thermistor (heat exchanger)
R5T	Thermistor (heat exchanger middle)
R6T	Thermistor (liquid)
R7T	Thermistor (fin)
R8 (A1P)	Resistor
S1PH	High pressure switch
S1PL	Low pressure switch
SEG1-3 (A1P)	7-segment display
TC1 (A1P)	Signal transceiver circuit
U, V, W (A1P)	Connector
V1D (A1P)	Diode
V*R (A1P)	Diode module
X*A (A1P)	Connector
X1M	Terminal strip
Y1E, Y3E	Electronic expansion valve
Y1-2S	Solenoid valve (4-way valve)
Z*C	Noise filter (ferrite core)
Z*F (A1P)	Noise filter

* : optional # : field supply

- NOTES**
- Refer to the wiring diagram sticker (on the back of the front plate) for how to use the BS1-BS3 and DS1 switches.
 - When operating, do not short-circuit protection device(s) S1PH, S1PL and Q1E.
 - Refer to the combination table and the option manual for how to connect the wiring to X6A, X28A and X77A.
 - Colours: BLK:black; RED:red; BLU:blue; WHT:white; GRN:green
 - Windings: L-N: 2 - Earth: 1

4D109936A

10 Wiring diagrams

10 - 1 Wiring Diagrams - Single Phase

10

AZAS125-140MV1
RZAG100-140MV1
RZASG125-140MV1

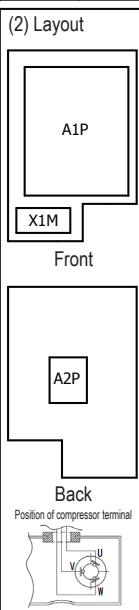
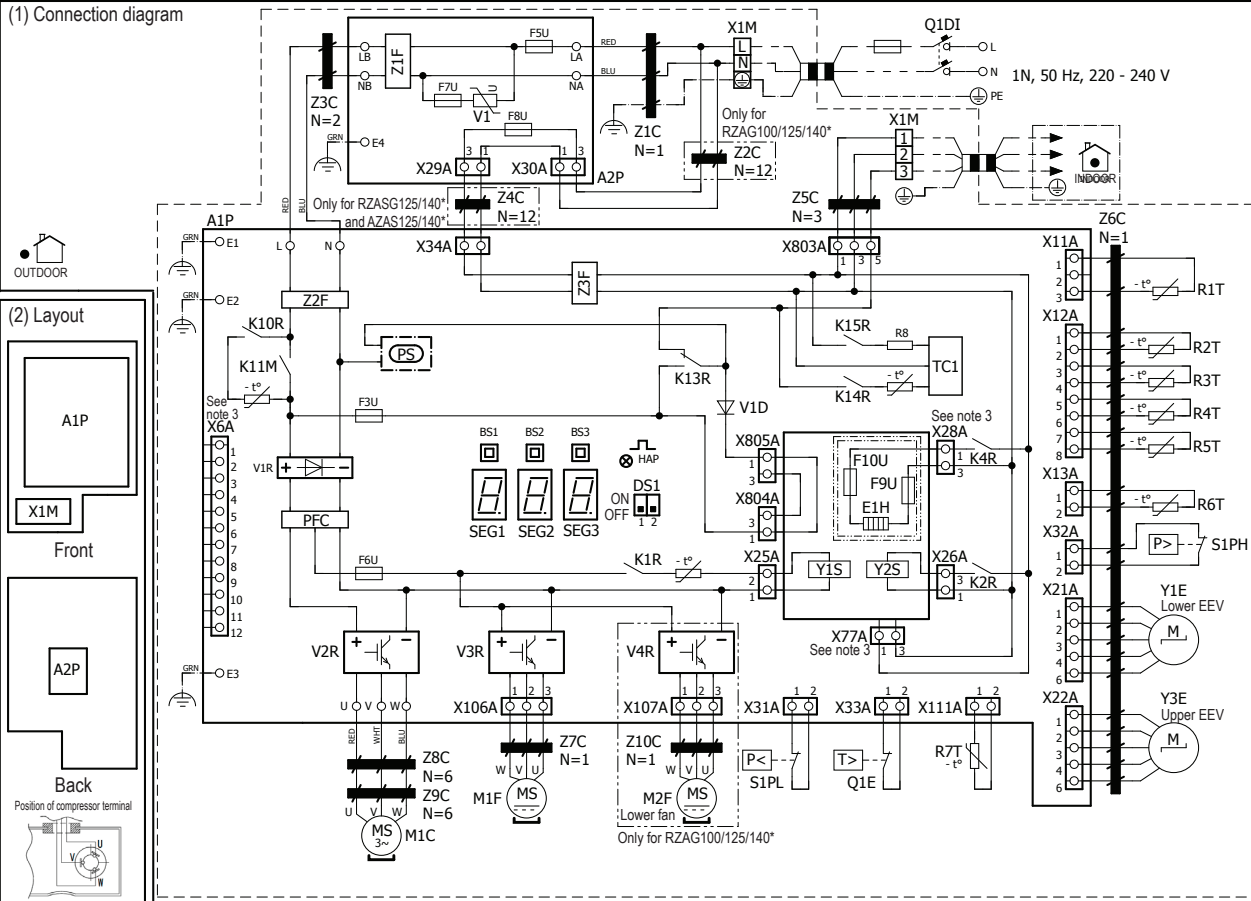

(3) NOTES

- ⬤ : Connection
- X1M : Main terminal
- : Earth wiring
- ⋯ : Field supply
- ① : Several wiring possibilities
- ⊕ : Protective earth
- : Field wire
- ⋯ : Wiring depending on model
- ⋯ : Option
- ⋯ : switch box
- ⋯ : PCB

(4) LEGEND

Part n°	Description
A1P	Printed circuit board (main)
A2P	Printed circuit board (noise filter)
BS1-3 (A1P)	Push-button switch
DS1(A1P)	Dipswitch
E1-3 (A1-2P)	Connector
E1H	* Bottom plate heater
F3U (A1P)	Fuse T 6,3 A 250 V
F5U (A2P)	Fuse T 56 A 250V
F6U (A1P)	Fuse T 5 A 250V
F7U (A2P)	Fuse T 6,3 A 250 V
F8U (A2P)	Fuse T 6,3 A 250 V
F9-10U	* Fuse F 1 A 250 V
HAP (A1P)	Light-emitting diode (service monitor is green)
K1R (A1P)	Magnetic relay (Y1S)
K2R (A1P)	Magnetic relay (Y2S)
K4R (A1P)	Magnetic relay (E1H)
K13-15R, K10R (A1P)	Magnetic relay
K11M (A1P)	Magnetic contactor
L* (A1-2P)	Connector
M1C	Compressor motor
M1-2F	Fan motor
PFC (A1P)	Power factor correction
PS (A1P)	Switching power supply

Part n°	Description
Q1DI	Earth leakage circuit breaker (30mA)
Q1E	Overload protection
R1T	Thermistor (air)
R2T	Thermistor (discharge)
R3T	Thermistor (suction)
R4T	Thermistor (heat exchanger)
R5T	Thermistor (heat exchanger middle)
R6T	Thermistor (liquid)
R7T	Thermistor (fin)
R8 (A1P)	Resistor
S1PH	High pressure switch
S1PL	Low pressure switch
SEG1-3 (A1P)	7-segment display
TC1 (A1P)	Signal transceiver circuit
U, V, W (A1P)	Connector
V1 (A2P)	Varistor
V1D (A1P)	Diode
V*R (A1P)	Diode module
X*A (A1-2P)	Connector
X1M	Terminal strip
Y1E, Y3E	Electronic expansion valve
Y1-2S	Solenoid valve (4-way valve)
Z*C	Noise filter (ferrite core)
Z*F (A1-2P)	Noise filter

* : optional # : field supply

NOTES

- Refer to the wiring diagram sticker (on the back of the front plate) for how to use the BS1-BS3 and DS1 switches.
- When operating, do not short-circuit protection device(s) S1PH, S1PL and Q1E.
- Refer to the combination table and the option manual for how to connect the wiring to X6A, X28A and X77A.
- Colours: BLK:black; RED:red; BLU:blue; WHT:white; GRN:green

4D109863A

11 Sound data

11 - 1 Sound Power Spectrum

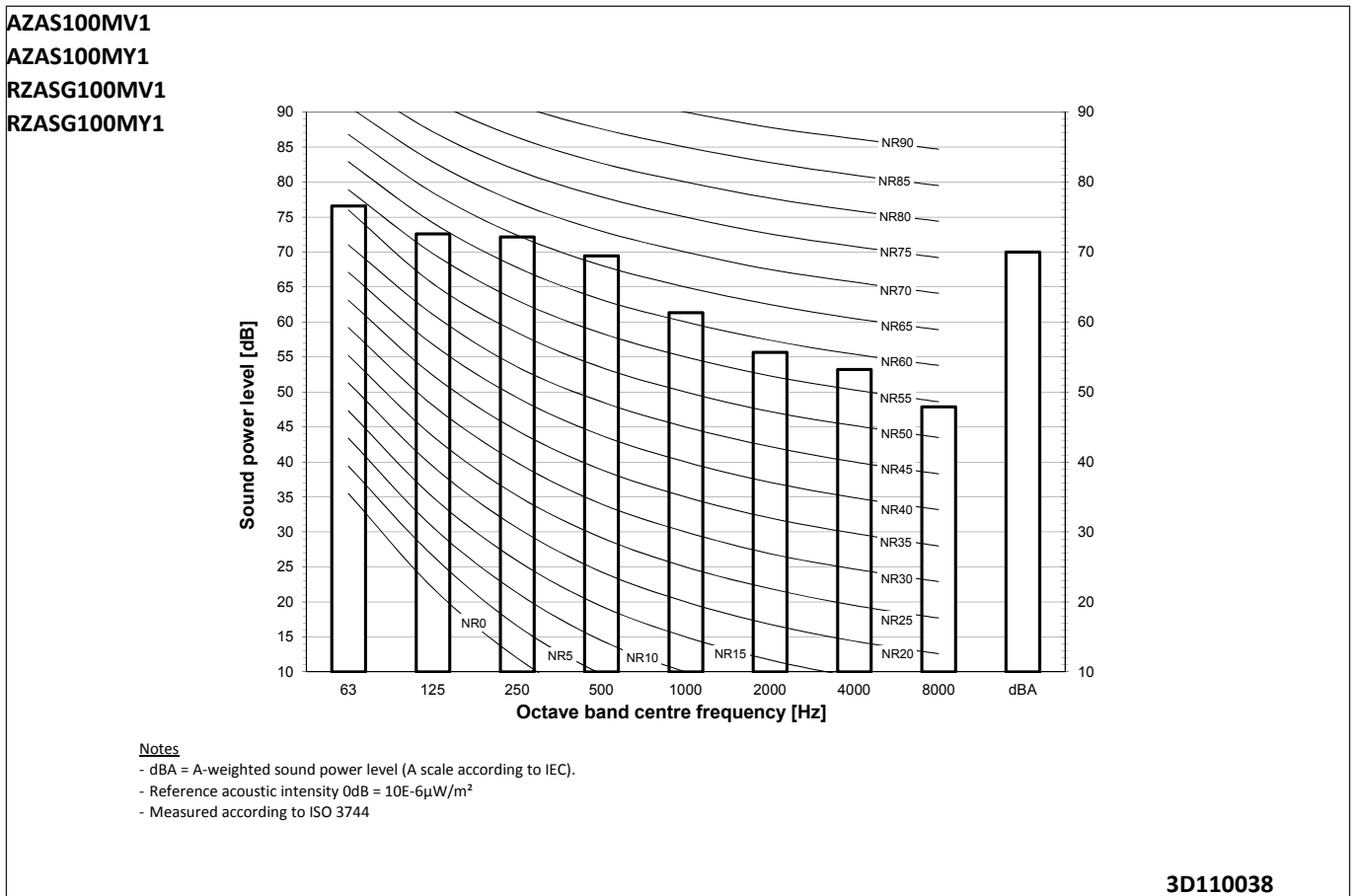
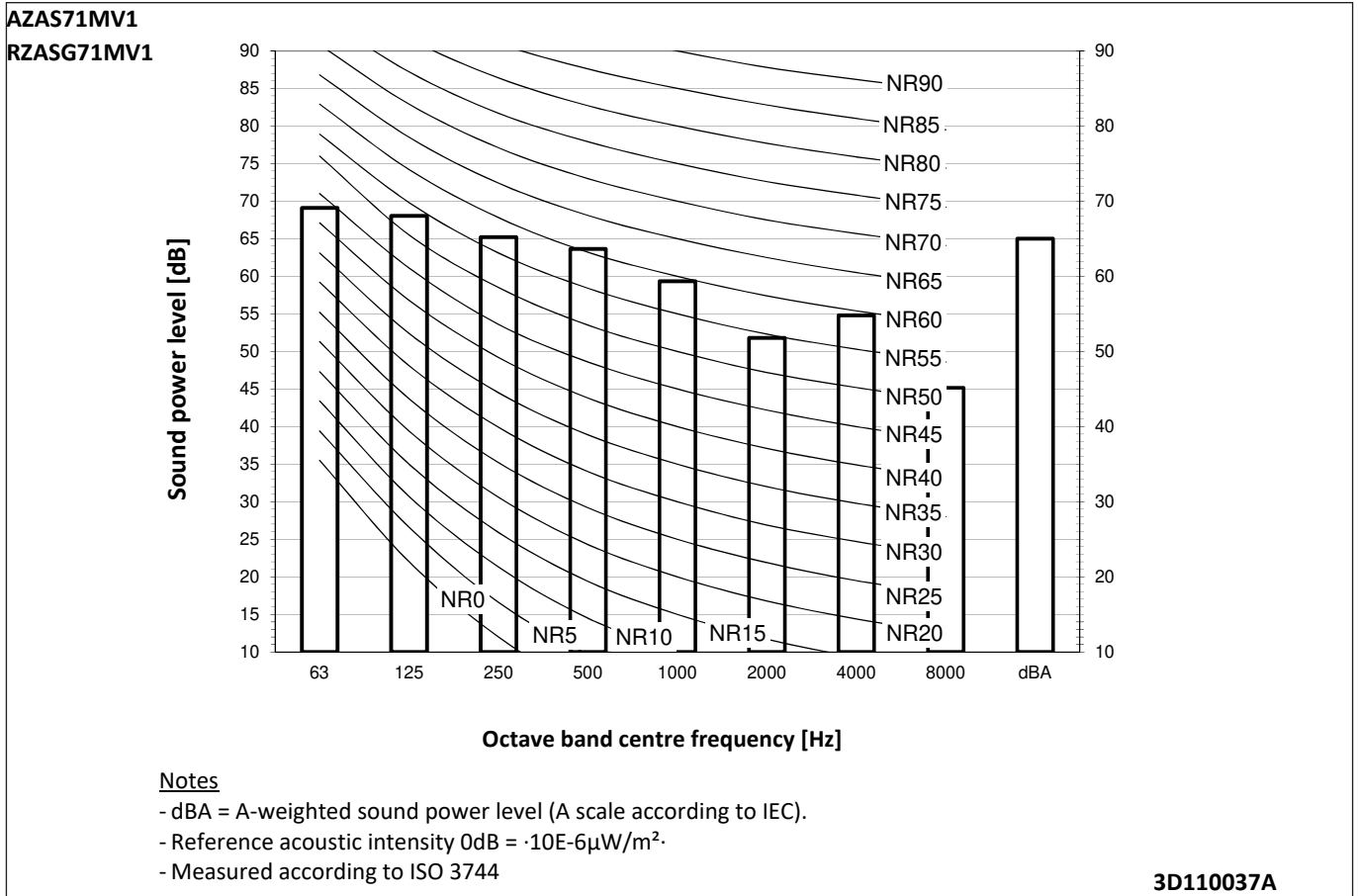

11 Sound data

11 - 1 Sound Power Spectrum

11

AZAS125MV1
 AZAS125MY1
 RZASG125MV1
 RZASG125MY1

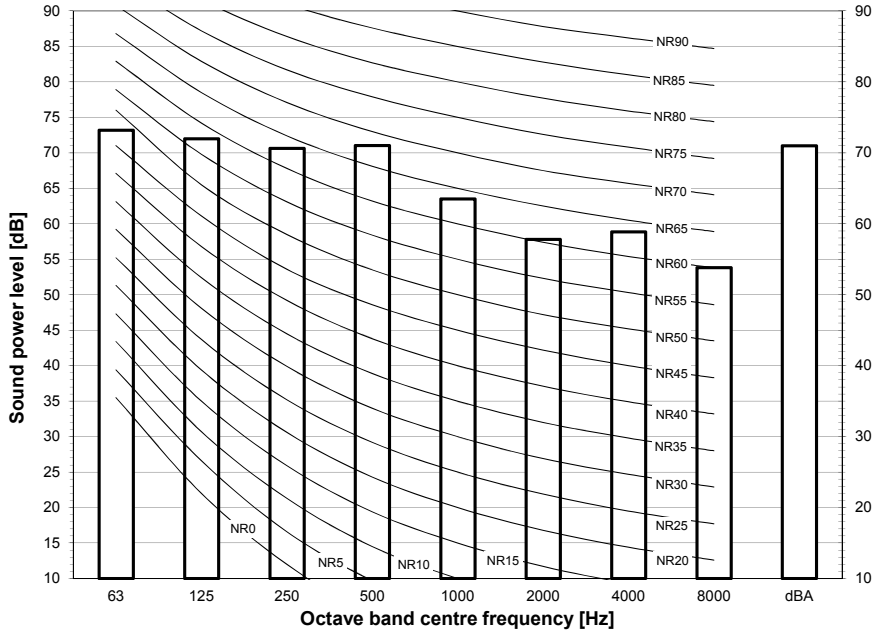

Notes

- dBA = A-weighted sound power level (A scale according to IEC).
- Reference acoustic intensity 0dB = 10E-6μW/m²
- Measured according to ISO 3744

3D110039

AZAS140MV1
 AZAS140MY1
 RZASG140MV1
 RZASG140MY1

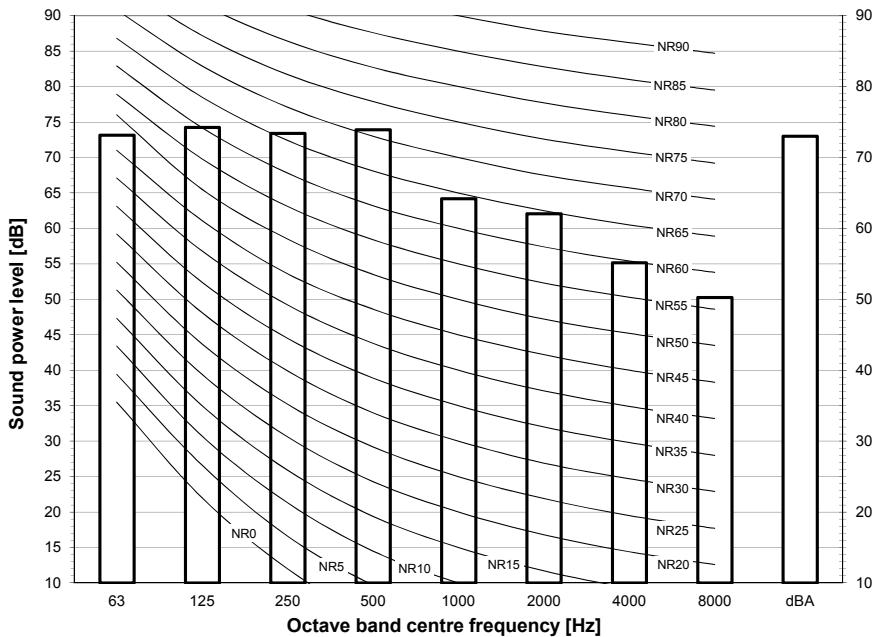

Notes

- dBA = A-weighted sound power level (A scale according to IEC).
- Reference acoustic intensity 0dB = 10E-6μW/m²
- Measured according to ISO 3744

3D110040

11 Sound data

11 - 2 Sound Pressure Spectrum - Cooling

AZAS71MV1
RZASG71MV1

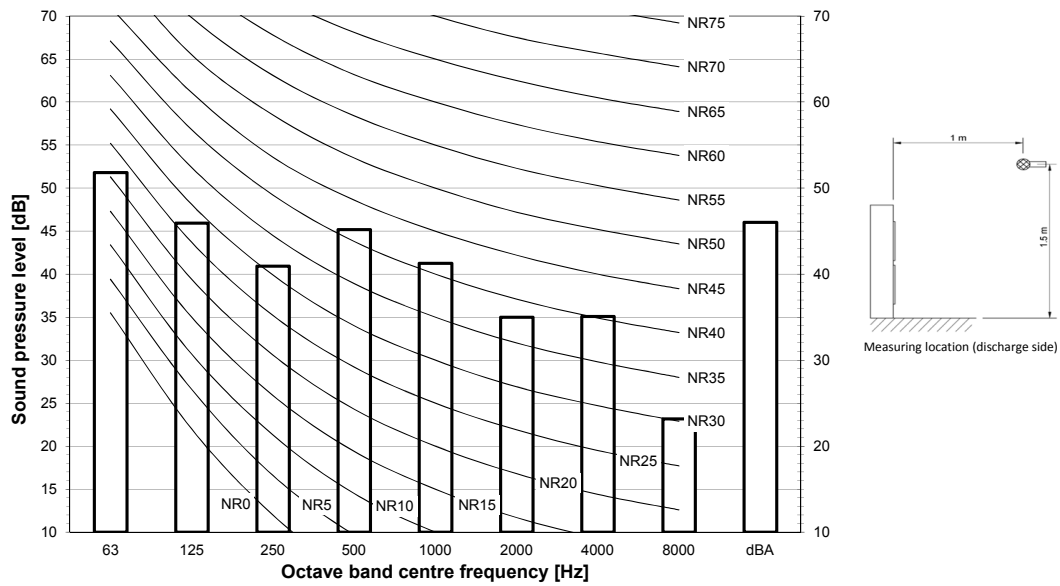

- Notes**
- Data is valid at free field condition.
 - Data is valid at nominal operation condition.
 - dBA = A-weighted sound pressure level (A scale according to IEC).
 - Reference acoustic pressure 0 dB = 20 μPa

3D110049

AZAS100MV1
AZAS100MY1
RZASG100MV1
RZASG100MY1

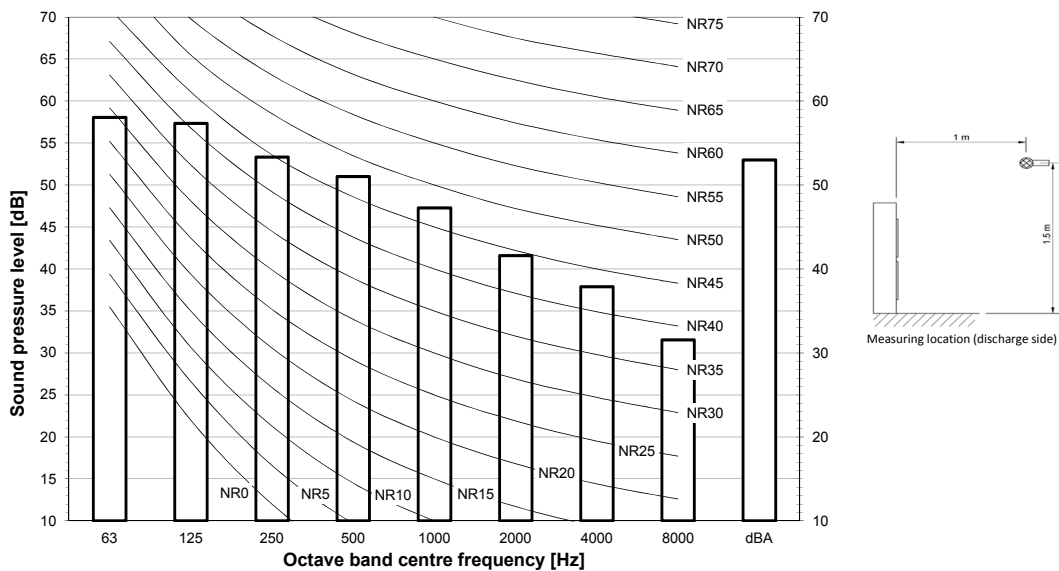

- Notes**
- Data is valid at free field condition.
 - Data is valid at nominal operation condition.
 - dBA = A-weighted sound pressure level (A scale according to IEC).
 - Reference acoustic pressure 0 dB = 20 μPa

3D110050

11 Sound data

11 - 2 Sound Pressure Spectrum - Cooling

11

AZAS125MV1
 AZAS125MY1
 RZASG125MV1
 RZASG125MY1

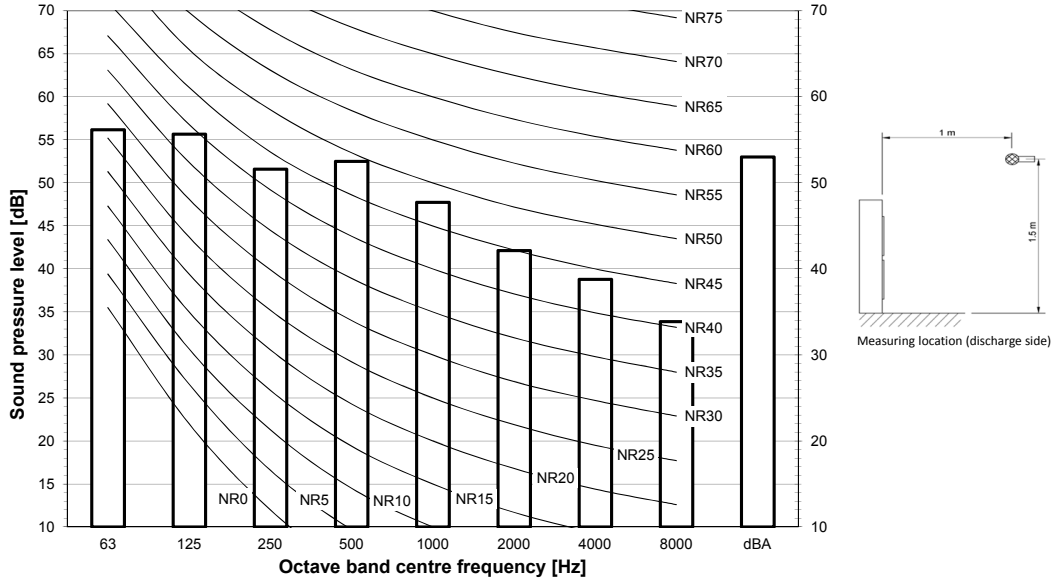

- Notes**
- Data is valid at free field condition.
 - Data is valid at nominal operation condition.
 - dBA = A-weighted sound pressure level (A scale according to IEC).
 - Reference acoustic pressure 0 dB = 20 μPa

3D110051

AZAS140MV1
 AZAS140MY1
 RZASG140MV1
 RZASG140MY1

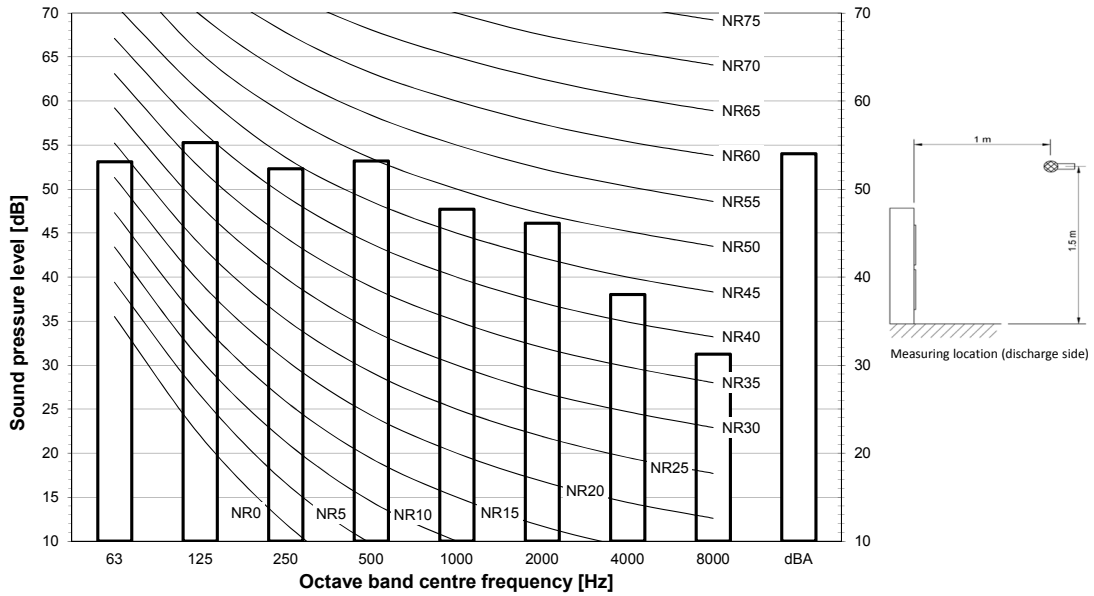

- Notes**
- Data is valid at free field condition.
 - Data is valid at nominal operation condition.
 - dBA = A-weighted sound pressure level (A scale according to IEC).
 - Reference acoustic pressure 0 dB = 20 μPa

3D111310

11 Sound data

11 - 3 Sound Pressure Spectrum - Heating

AZAS71MV1
RZASG71MV1

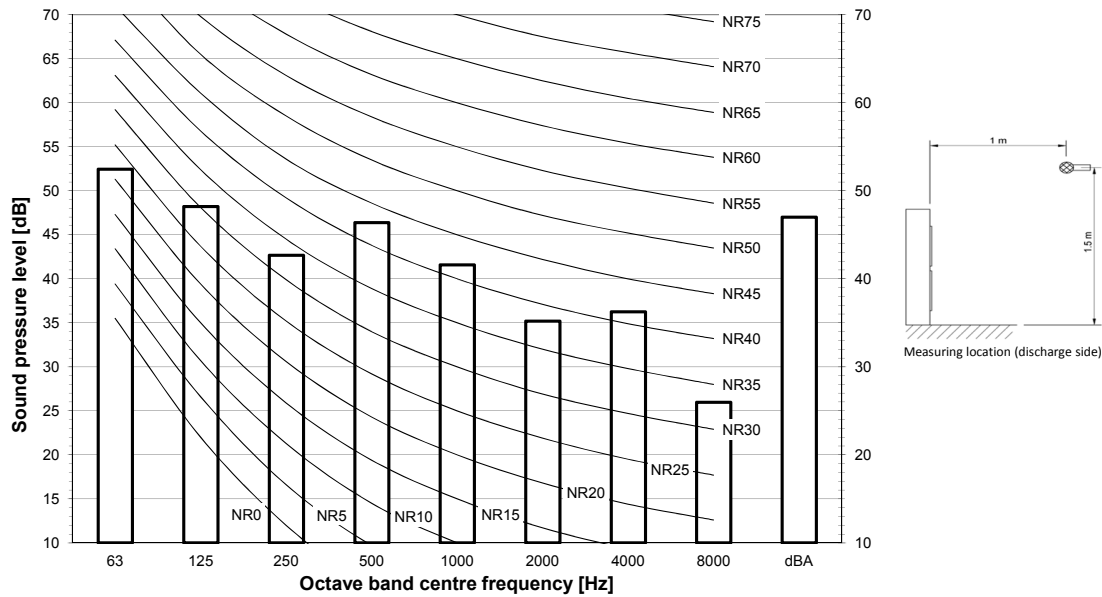

Notes

- Data is valid at free field condition.
- Data is valid at nominal operation condition.
- dBA = A-weighted sound pressure level (A scale according to IEC).
- Reference acoustic pressure 0 dB = 20 µPa

3D111293

AZAS100MV1
AZAS100MY1
RZASG100MV1
RZASG100MY1

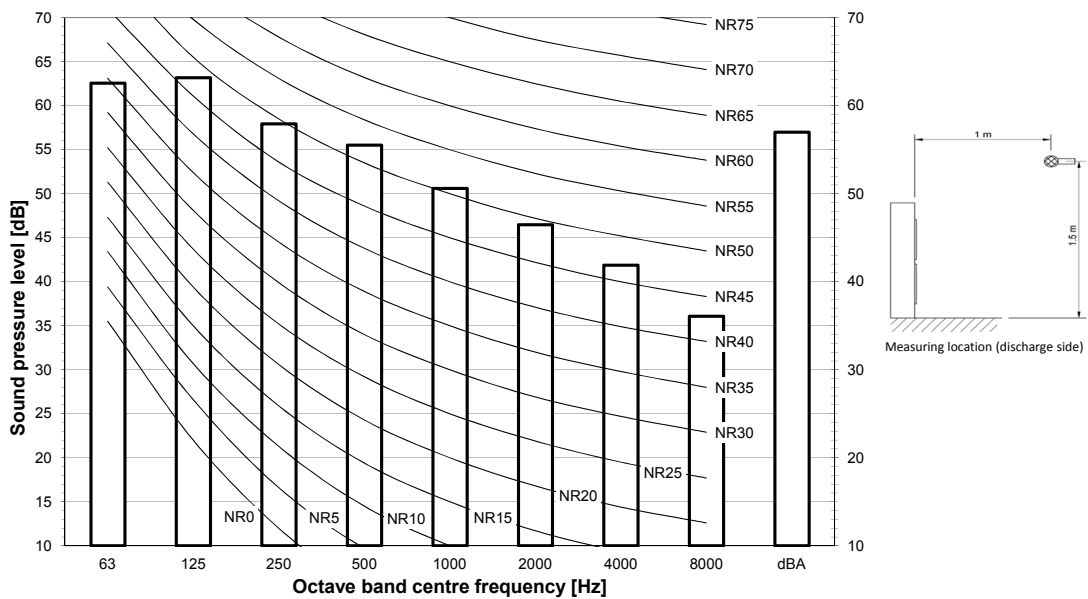

Notes

- Data is valid at free field condition.
- Data is valid at nominal operation condition.
- dBA = A-weighted sound pressure level (A scale according to IEC).
- Reference acoustic pressure 0 dB = 20 µPa

3D111294

11 Sound data

11 - 3 Sound Pressure Spectrum - Heating

11

AZAS125MV1
 AZAS125MY1
 RZASG125MV1
 RZASG125MY1

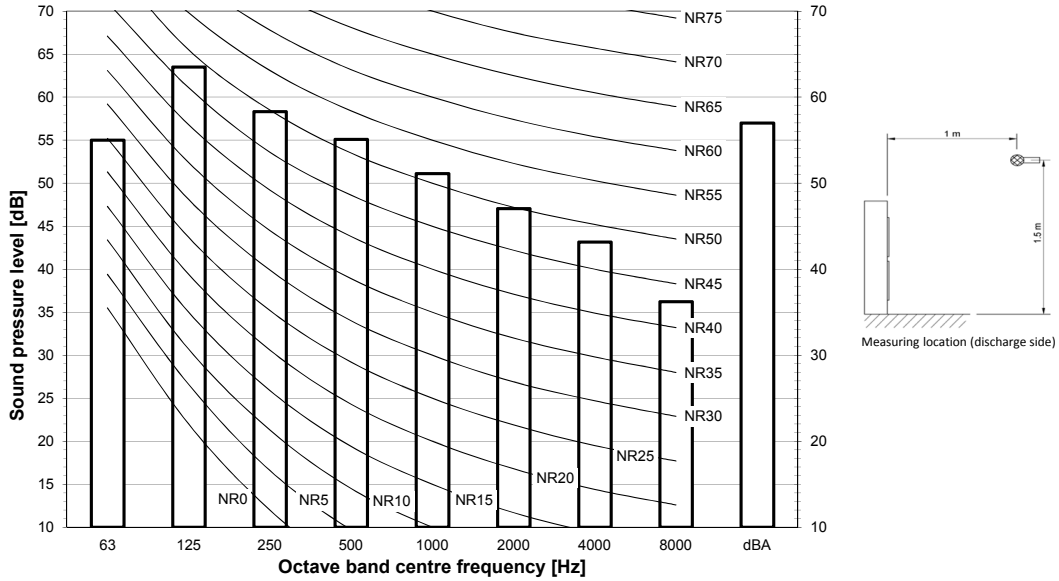

- Notes**
- Data is valid at free field condition.
 - Data is valid at nominal operation condition.
 - dBA = A-weighted sound pressure level (A scale according to IEC).
 - Reference acoustic pressure 0 dB = 20 μPa

3D111295

AZAS140MV1
 AZAS140MY1
 RZASG140MV1
 RZASG140MY1

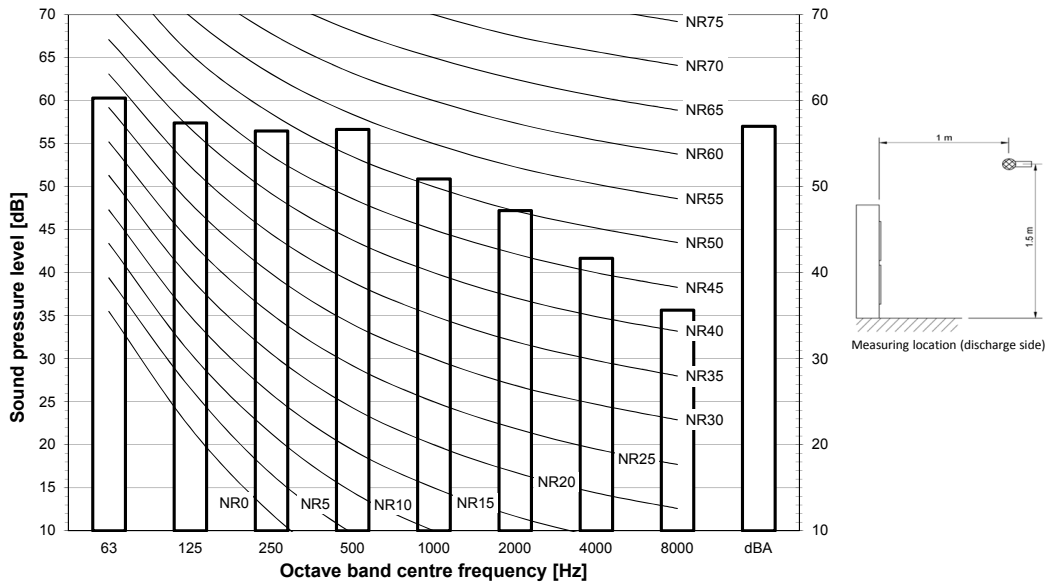

- Notes**
- Data is valid at free field condition.
 - Data is valid at nominal operation condition.
 - dBA = A-weighted sound pressure level (A scale according to IEC).
 - Reference acoustic pressure 0 dB = 20 μPa

3D111296

11 Sound data

11 - 4 Sound Pressure Spectrum Quiet Mode

AZAS71MV1
RZASG71MV1

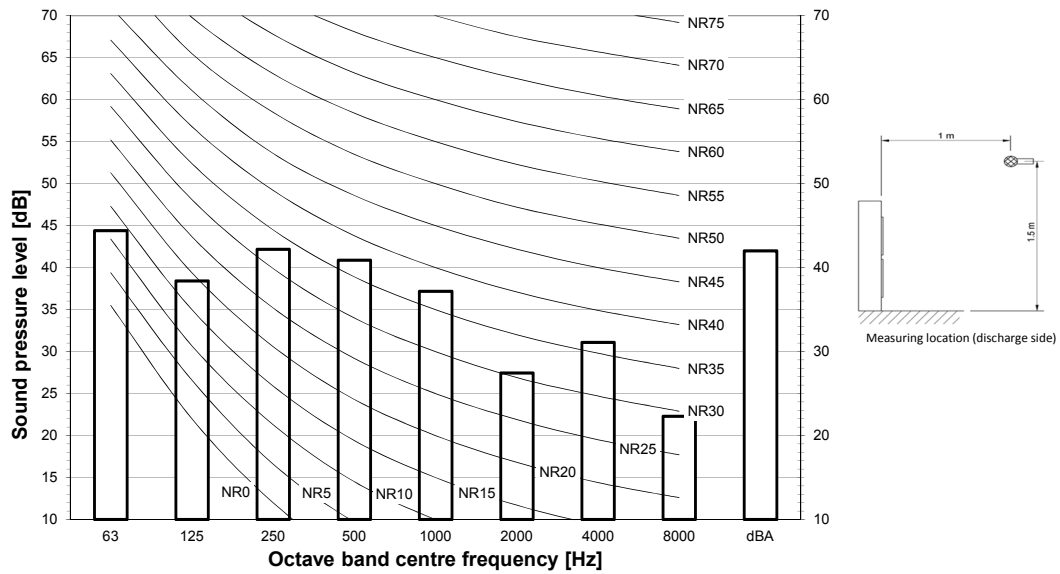

- Notes**
- Data is valid at free field condition.
 - Data is valid at nominal operation condition.
 - dBA = A-weighted sound pressure level (A scale according to IEC).
 - Reference acoustic pressure 0 dB = 20 μPa

3D111315

AZAS100MV1
AZAS100MY1
RZASG100MV1
RZASG100MY1

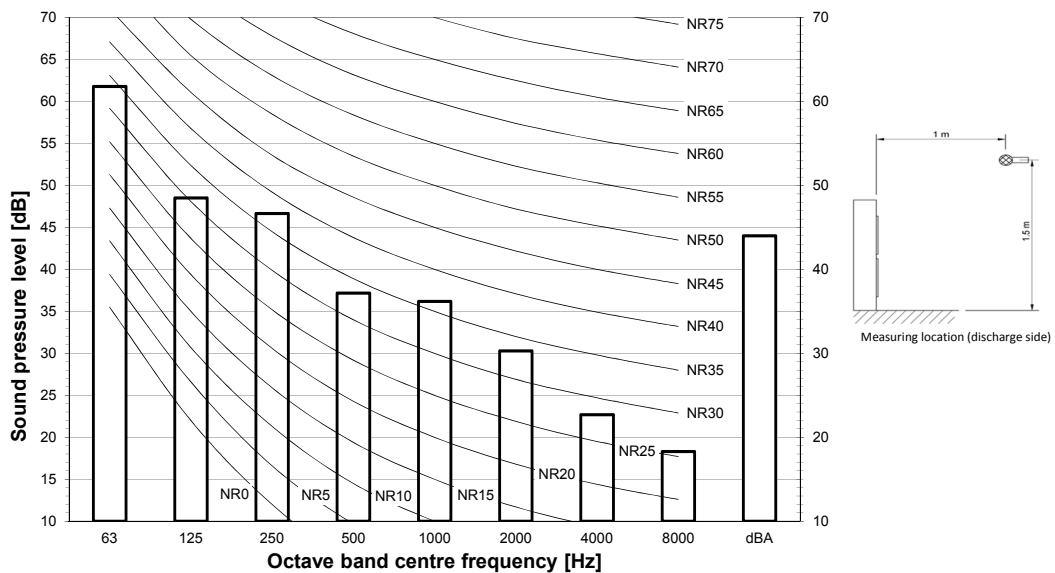

- Notes**
- Data is valid at free field condition.
 - Data is valid at nominal operation condition.
 - dBA = A-weighted sound pressure level (A scale according to IEC).
 - Reference acoustic pressure 0 dB = 20 μPa

3D111316

11 Sound data

11 - 4 Sound Pressure Spectrum Quiet Mode

11

AZAS125MV1
 AZAS125MY1
 RZASG125MV1
 RZASG125MY1

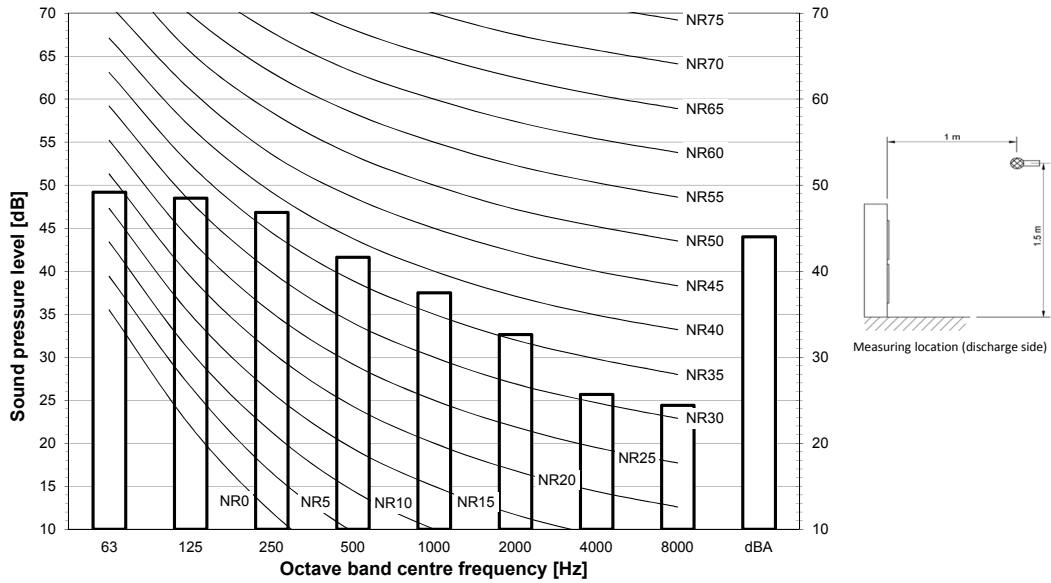

- Notes**
- Data is valid at free field condition.
 - Data is valid at nominal operation condition.
 - dBA = A-weighted sound pressure level (A scale according to IEC).
 - Reference acoustic pressure 0 dB = 20 μPa

3D111317

AZAS140MV1
 AZAS140MY1
 RZASG140MV1
 RZASG140MY1

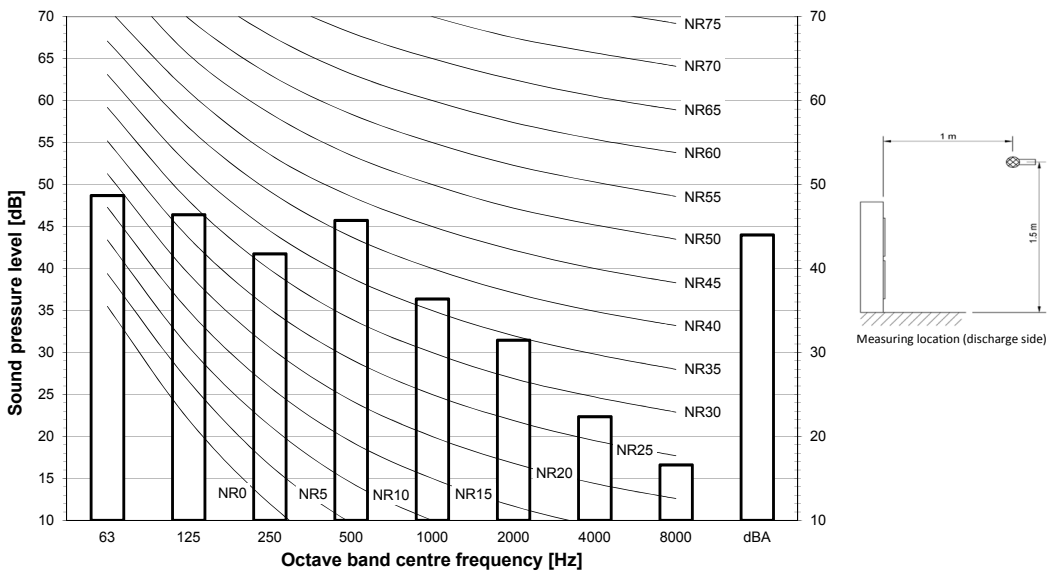

- Notes**
- Data is valid at free field condition.
 - Data is valid at nominal operation condition.
 - dBA = A-weighted sound pressure level (A scale according to IEC).
 - Reference acoustic pressure 0 dB = 20 μPa

3D111318

12 Installation

12 - 1 Installation Method

RZAG-MV1
RZAG-MY1
RZASG-MV1
RZASG-MY1
AZAS-MV1
AZAS-MY1

Installation service space

The measure of these values is "mm".

(A) When there are obstacles on suction sides.

● No obstacle above

- ① Stand-alone installation
 - Obstacle on the suction side only

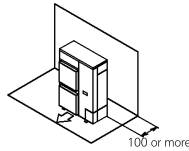

- Obstacle on both sides and suction side, too

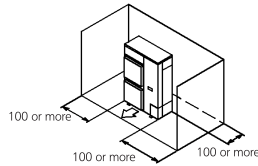

- ② Series installation (2 or more) (Note 1)
 - Obstacle on the suction side and both sides

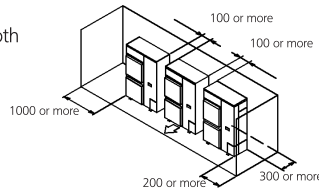

● Obstacle above, too.

- ① Stand-alone installation
 - Obstacle on the suction side, too

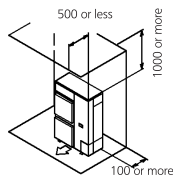

- Obstacle on both sides and suction side, too

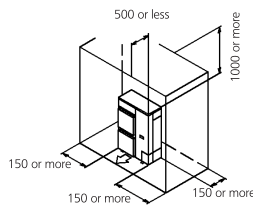

- ② Series installation (2 or more) (Note 1)
 - Obstacle on the suction side and both sides

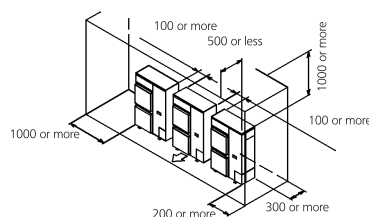

(B) When there are obstacles on discharge sides.

● No obstacle above

- ① Stand-alone installation
 - Obstacle on the discharge side only

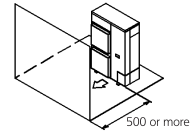

- ② Series installation (2 or more) (Note 1)
 - Obstacle on the discharge side only

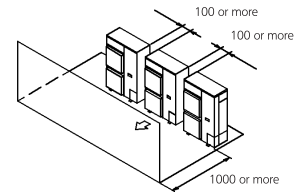

● Obstacle above, too

- ① Stand-alone installation
 - Obstacle on the discharge side only, too

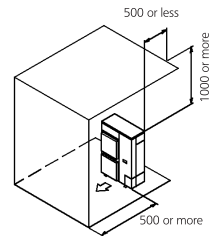

- ② Series installation (2 or more) (Note 1)
 - Obstacle on the discharge side

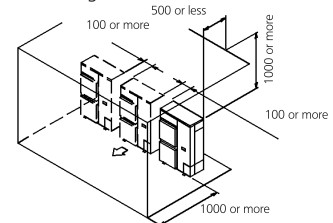

(C) When there are obstacles on both suction and discharge sides.:

Pattern 1

When the obstacles on the discharge side is higher than the unit. (L>H)
(There is no limit for the height of obstructions on the suction side.)

● No obstacle above

- ① Stand-alone installation
 - No obstacle above

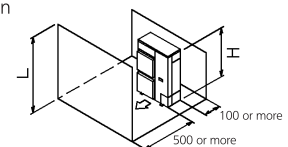

- ② Series installation (2 or more) (Note 1)
 - No obstacle above

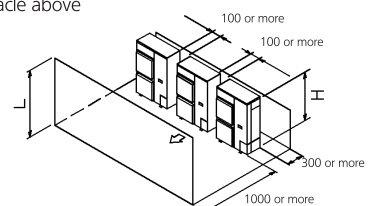

3D069554

12 Installation

12 - 1 Installation Method

RZAG-MV1
 RZAG-MY1
 RZASG-MV1
 RZASG-MY1
 AZAS-MV1
 AZAS-MY1

● **Obstacle above, too**

- ① Stand-alone installation (Note 2)
 - When there are obstacles on suction, discharge and top sides.

The relations between H, A and L are as follows.

	L	A
$L \leq H$	$L \leq 1/2 H$	750 or more
	$1/2 H < L \leq H$	1000 or more
$L > H$	Set the stand as : $L \leq H$ Refer to the column of $L \leq H$ for A	

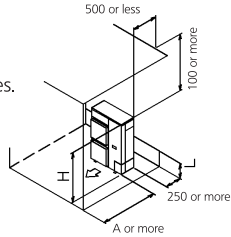

- ② Series installation (2 or more) (Note 1, 2)
 - When there are obstacles on suction, discharge and top sides.

The relations between H, A and L are as follows.

	L	A
$L \leq H$	$L \leq 1/2 H$	1000 or more
	$1/2 H < L \leq H$	1250 or more
$L > H$	Set the stand as : $L \leq H$ Refer to the column of $L \leq H$ for A	

Limit of series installation is 2 units.

Pattern 2

When the obstacle on the discharge side is lower than the unit ($L \leq H$) (There is no limit for the height of obstructions on the suction side.)

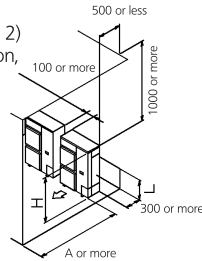

● **No obstacle above**

- ① Stand-alone installation
 - No obstacle above

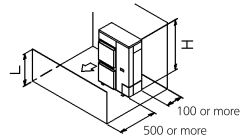

- ② Series installation (2 or more) (Note 1, 2)
 - When there are obstacles on both suction and discharge sides.

The relations between H, A and L are as follows.

L	A
$L \leq 1/2 H$	250 or more
$1/2 H < L \leq H$	300 or more

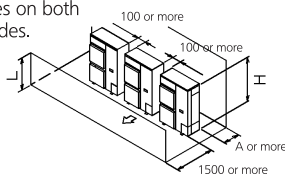

● **obstacle above**

- ① Stand-alone installation (Note 2)
 - When there are obstacles on suction, discharge and top sides.

The relations between H, A and L are as follows.

	L	A
$L \leq H$	$L \leq 1/2 H$	100 or more
	$1/2 H < L \leq H$	200 or more
$L > H$	Set the stand as : $L \leq H$ Refer to the column of $L \leq H$ for A	

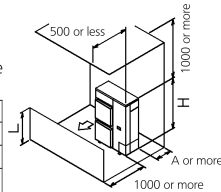

- ② Series installation (2 or more) (Note 1, 2)
 - When there are obstacles on suction, discharge and top sides.

The relations between H, A and L are as follows.

	L	A
$L \leq H$	$L \leq 1/2 H$	250 or more
	$1/2 H < L \leq H$	300 or more
$L > H$	Set the stand as : $L \leq H$ Refer to the column of $L \leq H$ for A	

Limit of series installation is 2 units.

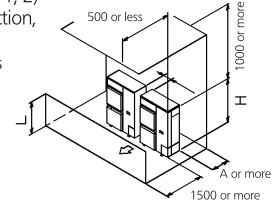

(D) Double-decker installation

- ① Obstacle on the discharge side. (1)
 - Do not exceed two levels for stacked installation.
 - Install a roof cover similar to A (field supply), as outdoor units with downward drainage are prone to dripping and freezing.
 - Install the upper-level outdoor unit so that its bottom plate is a sufficient height above the roof cover. This is to prevent the buildup of ice on the underside of the bottom plate.
- ② Obstacle on the suction side. (1)
 - Do not exceed two levels for stacked installation.
 - Install a roof cover similar to A (field supply), as outdoor units with downward drainage are prone to dripping and freezing.
 - Install the upper-level outdoor unit so that its bottom plate is a sufficient height above the roof cover. This is to prevent the buildup of ice on the underside of the bottom plate.

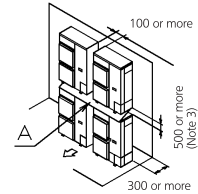
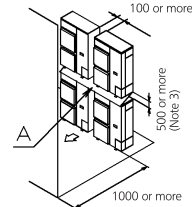

(E) Multiple rows of series installation (on the rooftop, etc.)

- ① One row of stand-alone installation

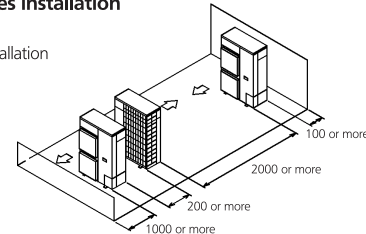

- ② Rows of series installation (2 or more)
 - The relations between H, A and L are as follows.

	L	A
$L \leq H$	$L \leq 1/2 H$	250 or more
	$1/2 H < L \leq H$	300 or more
$L > H$	Can not be installed	

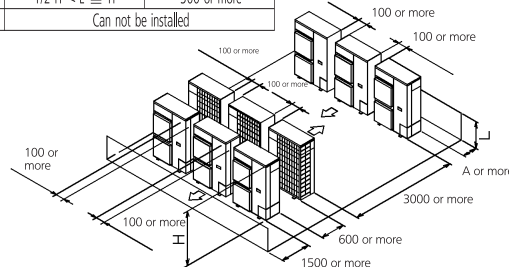

NOTES

- In case of the sideways's piping, make a 100mm gap between the unit above.
- Close the bottom of the installation frame to prevent the discharged air from being bypassed.
- It is not necessary to install a roof cover if there is no danger of drainage dripping and freezing. In this case, the space between the upper and lower outdoor units should be at least 100mm. Close off the gap between the upper and lower units so there is no re intake of discharged air.

13 Operation range

13 - 1 Operation Range

RZASG-MV1
RZASG-MY1

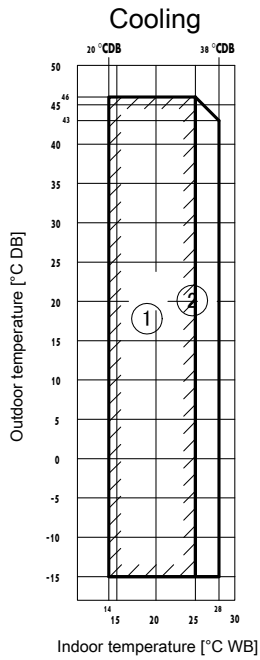

- ① Operation range
- ② Pull-down operation range
- ③ Warm-up operation range

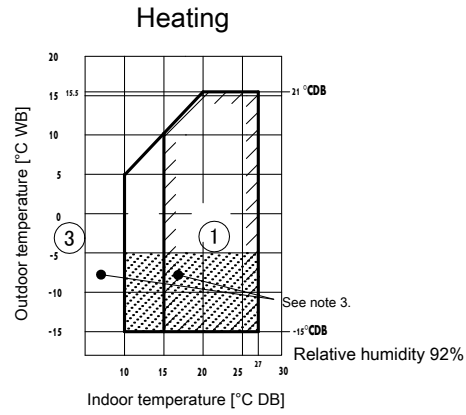

Notes

1. Depending on operation and installation conditions, the indoor unit can change over to freeze-up operation (indoor de-icing).
2. To reduce the freeze-up operation (indoor de-icing) frequency, it is recommended to install the outdoor unit in a location not exposed to wind.
3. In case of high humidity conditions (> 92%) at ambient temperatures of < -5°C, a RZAG model should be used instead to avoid freeze-up of the outdoor unit.

3D110021

14 Appropriate Indoors

14 - 1 Appropriate Indoors

AZAS-MV1
AZAS-MY1
RZAG-MV1
RZASG-MV1
RZASG-MY1

Recommended combinations
ENER Lot 21

P= Pair
 2= Twin
 3= Triple
 4= Double twin

Notes

1. -ADEA* - can only be used in combination with -AZAS*M*V1B-

Sky Air		High Cassette				Thin cassette				2x2 cassette		Duct (medium ESP)			Concealed floor standing type			Ceiling-mounted - 4-way blow		Wall mounted type		Duct (high ESP)												
Model		FCAHG71	FCAG100	FCAG125	FCAG140	FCAG35	FCAG50	FCAG60	FCAG71	FCAG100	FCAG125	FCAG140	FFA35	FFA50	FFA60	FBA35	FBA50	FBA60	FBA71	FBA100	FBA125	FBA140	FNA35	FNA50	FNA60	FUA71	FUA100	FUA125	FAA71	FAA100	FDA125			
RZAG125M7V1B	RZAG125M7Y1B			P		4										4						P										P		
RZAG140M7V1B	RZAG140M7Y1B				P	4										4							P											
RZASG125M7V1B	RZASG125M7Y1B					4										4																P		
RZASG140M7V1B	RZASG140M7Y1B					4										4																	P	
AZAS125M7V1B	AZAS125M7Y1B																																	
AZAS140M7V1B	AZAS140M7Y1B																																	

Sky Air		Floor standing type				Slim duct			Ceiling-suspended				Duct (medium ESP)			Floor standing type						
Model		FVA71	FVA100	FVA125	FVA140	FDX35	FDX50	FDX60	FHA35	FHA50	FHA60	FHA71	FHA100	FHA125	FHA140	ADEA35	ADEA50	ADEA60	ADEA71	ADEA100	ADEA125	AVA125
RZAG125M7V1B	RZAG125M7Y1B			P										P								
RZAG140M7V1B	RZAG140M7Y1B				P										P							
RZASG125M7V1B	RZASG125M7Y1B			P																		
RZASG140M7V1B	RZASG140M7Y1B				P																	
AZAS125M7V1B	AZAS125M7Y1B																					P
AZAS140M7V1B	AZAS140M7Y1B																					P

3D112646B

AZAS-MV1
AZAS-MY1
RZAG-MV1
RZASG-MV1
RZASG-MY1

ENER Lot 21
 Appropriate indoor units

Connectable to -RZAG125M7V1B / RZAG125M7Y1B- and covered by -ENER Lot 21-

FCAHG125	FCAG35	FFA35	FBA35	FNA35	FUA125	-	-	FDA125	FVA125	FDX35	FHA35	-	-
-	FCAG50	FFA50	FBA50	FNA50	-	-	-	-	-	FDX50	FHA50	-	-
-	FCAG60	FFA60	FBA60	FNA60	-	-	-	-	-	FDX60	FHA60	-	-
-	FCAG125	-	FBA125	-	-	-	-	-	-	-	FHA125	-	-

Connectable to -RZAG125M7V1B / RZASG125M7Y1B- and covered by -ENER Lot 21-

-	FCAG35	FFA35	FBA35	FNA35	FUA125	-	-	FDA125	FVA125	FDX35	FHA35	-	-
-	FCAG50	FFA50	FBA50	FNA50	-	-	-	-	-	FDX50	FHA50	-	-
-	FCAG60	FFA60	FBA60	FNA60	-	-	-	-	-	FDX60	FHA60	-	-
-	FCAG125	-	FBA125	-	-	-	-	-	-	-	FHA125	-	-

Connectable to -AZAS125M7V1B / AZAS125M7Y1B- and covered by -ENER Lot 21-

-	FCAG125	-	FBA125	-	-	-	-	-	-	-	-	AVA125	ADEA125
---	---------	---	--------	---	---	---	---	---	---	---	---	--------	---------

Connectable to -RZAG140M7V1B / RZAG140M7Y1B- and covered by -ENER Lot 21-

FCAHG140	FCAG35	FFA35	FBA35	FNA35	FUA71	FAA71	-	-	FVA71	FDX35	FHA35	-	-
-	FCAG50	FFA50	FBA50	FNA50	-	-	-	-	FVA140	FDX50	FHA50	-	-
-	FCAG71	-	FBA71	-	-	-	-	-	-	-	FHA71	-	-
-	FCAG140	-	FBA140	-	-	-	-	-	-	-	FHA140	-	-

Connectable to -RZASG140M7V1B / RZASG140M7Y1B- and covered by -ENER Lot 21-

-	FCAG35	FFA35	FBA35	FNA35	FUA71	FAA71	-	-	FVA71	FDX35	FHA35	-	-
-	FCAG50	FFA50	FBA50	FNA50	-	-	-	-	FVA140	FDX50	FHA50	-	-
-	FCAG71	-	FBA71	-	-	-	-	-	-	-	FHA71	-	-
-	FCAG140	-	FBA140	-	-	-	-	-	-	-	FHA140	-	-

Connectable to -AZAS140M7V1B / AZAS140M7Y1B- and covered by -ENER Lot 21-

-	FCAG140	-	FBA140	-	-	-	-	-	-	-	-	-	-
---	---------	---	--------	---	---	---	---	---	---	---	---	---	---

ENER Lot 10
 Appropriate indoor units

Connectable to -RZAG1M7V1B / RZAG1M7Y1B- and covered by -ENER Lot 10-

FCAHG71	FCAG35	FFA35	FBA35	FNA35	FUA71	FAA71	-	-	FVA71	FDX35	FHA35	-	-
-	FCAG71	-	FBA71	-	-	-	-	-	-	-	FHA71	-	-

Connectable to -RZASG1M2V1B- and covered by -ENER Lot 10-

-	FCAG35	FFA35	FBA35	FNA35	FUA71	FAA71	-	-	FVA71	FDX35	FHA35	-	-
-	FCAG71	-	FBA71	-	-	-	-	-	-	-	FHA71	-	-

Connectable to -AZAS1M2V1B- and covered by -ENER Lot 10-

-	FCAG71	-	FBA71	-	-	FAA71	-	-	-	-	-	-	ADEA71
---	--------	---	-------	---	---	-------	---	---	---	---	---	---	--------

Connectable to -RZAG100M7V1B / RZAG100M7Y1B- and covered by -ENER Lot 10-

FCAHG100	FCAG35	FFA35	FBA35	FNA35	FUA100	FAA100	-	-	FVA100	FDX35	FHA35	-	-
-	FCAG50	FFA50	FBA50	FNA50	-	-	-	-	-	FDX50	FHA50	-	-
-	FCAG100	-	FBA100	-	-	-	-	-	-	-	FHA100	-	-

Connectable to -RZASG100M7V1B / RZASG100M7Y1B- and covered by -ENER Lot 10-

-	FCAG35	FFA35	FBA35	FNA35	FUA100	FAA100	-	-	FVA100	FDX35	FHA35	-	-
-	FCAG50	FFA50	FBA50	FNA50	-	-	-	-	-	FDX50	FHA50	-	-
-	FCAG100	-	FBA100	-	-	-	-	-	-	-	FHA100	-	-

Connectable to -AZAS100M7V1B / AZAS100M7Y1B- and covered by -ENER Lot 10-

-	FCAG100	-	FBA100	-	-	FAA100	-	-	-	-	-	-	ADEA100
---	---------	---	--------	---	---	--------	---	---	---	---	---	---	---------

3D112646B